

Pioneer

**AUDIO/VIDEO
MULTI-CHANNEL RECEIVER**

VSX-D309

Operating Instructions

Congratulations on buying this fine Pioneer product. Please read through these operating instructions so you will know how to operate your model properly. After you have finished reading the instructions, put them away in a safe place for future reference.

WARNING: TO PREVENT FIRE OR SHOCK HAZARD, DO NOT EXPOSE THIS APPLIANCE TO RAIN OR MOISTURE.

THE POWER SWITCH IS SECONDARY CONNECTED AND THEREFORE DOES NOT SEPARATE THE UNIT FROM MAINS POWER IN STANDBY POSITION.

IMPORTANT



The lightning flash with arrowhead symbol, within an equilateral triangle, is intended to alert the user to the presence of uninsulated "dangerous voltage" within the product's enclosure that may be of sufficient magnitude to constitute a risk of electric shock to persons.

CAUTION

**RISK OF ELECTRIC SHOCK
DO NOT OPEN**

CAUTION: TO PREVENT THE RISK OF ELECTRIC SHOCK, DO NOT REMOVE COVER (OR BACK). NO USER-SERVICEABLE PARTS INSIDE. REFER SERVICING TO QUALIFIED SERVICE PERSONNEL.



The exclamation point within an equilateral triangle is intended to alert the user to the presence of important operating and maintenance (servicing) instructions in the literature accompanying the appliance.

This equipment has been tested and found to comply with the limits for a Class B digital device, pursuant to Part 15 of the FCC Rules. These limits are designed to provide reasonable protection against harmful interference in a residential installation. This equipment generates, uses, and can radiate radio frequency energy and, if not installed and used in accordance with the instructions, may cause harmful interference to radio communications. However, there is no guarantee that interference will not occur in a particular installation. If this equipment does cause harmful interference to radio or television reception, which can be determined by turning the equipment off and on, the user is encouraged to try to correct the interference by one or more of the following measures:

- Reorient or relocate the receiving antenna.
- Increase the separation between the equipment and receiver.
- Connect the equipment into an outlet on a circuit different from that to which the receiver is connected.
- Consult the dealer or an experienced radio/TV technician for help.

IMPORTANT NOTICE

The serial number for this equipment is located on the base. Please write this serial number on your enclosed warranty card and keep it in a secure area. This is for your security.

[For Canadian model]

This Class B digital apparatus complies with Canadian ICES-003.

[Pour le modèle Canadien]

Cet appareil numérique de la classe B est conforme à la norme NMB-003 du Canada.

[For Canadian model]

CAUTION: TO PREVENT ELECTRIC SHOCK DO NOT USE THIS (POLARIZED) PLUG WITH AN EXTENSION CORD, RECEPTACLE OR OTHER OUTLET UNLESS THE BLADES CAN BE FULLY INSERTED TO PREVENT BLADE EXPOSURE.

ATTENTION: POUR PREVENIR LES CHOCS ELECTRIQUES NE PAS UTILISER CETTE FICHE POLARISEE AVEC UN PROLONGATEUR, UNE PRISE DE COURANT OU UNE AUTRE SORTIE DE COURANT, SAUF SI LES LAMES PEUVENT ETRE INSERES A FOND SANS EN LAISSER AUCUNE PARTIE A DECOUVERT.

CAUTION:

This product satisfies FCC regulations when shielded cables and connectors are used to connect the unit to other equipment. To prevent electromagnetic interference with electric appliances such as radios and televisions, use shielded cables and connectors for connections.

Information to User

Alteration or modifications carried out without appropriate authorization may invalidate the user's right to operate the equipment.

IMPORTANT SAFETY INSTRUCTIONS

READ INSTRUCTIONS — All the safety and operating instructions should be read before the product is operated.

RETAIN INSTRUCTIONS — The safety and operating instructions should be retained for future reference.

HEED WARNINGS — All warnings on the product and in the operating instructions should be adhered to.

FOLLOW INSTRUCTIONS — All operating and use instructions should be followed.

CLEANING — Unplug this product from the wall outlet before cleaning. The product should be cleaned only with a polishing cloth or a soft dry cloth. Never clean with furniture wax, benzene, insecticides or other volatile liquids since they may corrode the cabinet.

ATTACHMENTS — Do not use attachments not recommended by the product manufacturer as they may cause hazards.

WATER AND MOISTURE — Do not use this product near water — for example, near a bathtub, wash bowl, kitchen sink, or laundry tub; in a wet basement; or near a swimming pool; and the like.

ACCESSORIES — Do not place this product on an unstable cart, stand, tripod, bracket, or table. The product may fall, causing serious injury to a child or adult, and serious damage to the product. Use only with a cart, stand, tripod, bracket, or table recommended by the manufacturer, or sold with the product. Any mounting of the product should follow the manufacturer's instructions, and should use a mounting accessory recommended by the manufacturer.

CART — A product and cart combination should be moved with care. Quick stops, excessive force, and uneven surfaces may cause the product and cart combination to overturn.



VENTILATION — Slots and openings in the cabinet are provided for ventilation and to ensure reliable operation of the product and to protect it from overheating, and these openings must not be blocked or covered. The openings should never be blocked by placing the product on a bed, sofa, rug, or other similar surface. This product should not be placed in a built-in installation such as a bookcase or rack unless proper ventilation is provided or the manufacturer's instructions have been adhered to.

POWER SOURCES — This product should be operated only from the type of power source indicated on the marking label. If you are not sure of the type of power supply to your home, consult your product dealer or local power company.

LOCATION — The appliance should be installed in a stable location.

NONUSE PERIODS — The power cord of the appliance should be unplugged from the outlet when left un-used for a long period of time.

GROUNDING OR POLARIZATION

- If this product is equipped with a polarized alternating current line plug (a plug having one blade wider than the other), it will fit into the outlet only one way. This is a safety feature. If you are unable to insert the plug fully into the outlet, try reversing the plug. If the plug should still fail to fit, contact your electrician to replace your obsolete outlet. Do not defeat the safety purpose of the polarized plug.
- If this product is equipped with a three-wire grounding type plug, a plug having a third (grounding) pin, it will only fit into a grounding type power outlet. This is a safety feature. If you are unable to insert the plug into the outlet, contact your electrician to replace your obsolete outlet. Do not defeat the safety purpose of the grounding type plug.

POWER-CORD PROTECTION — Power-supply cords should be routed so that they are not likely to be walked on or pinched by items placed upon or against them, paying particular attention to cords at plugs, convenience receptacles, and the point where they exit from the product.

OUTDOOR ANTENNA GROUNDING — If an outside antenna or cable system is connected to the product, be sure the antenna or cable system is grounded so as to provide some protection against voltage surges and built-up static charges. Article 810 of the National Electrical Code, ANSI/NFPA 70, provides information with regard to proper grounding of the mast and supporting structure, grounding of the lead-in wire to an antenna discharge unit, size of grounding conductors, location of antenna-discharge unit, connection to grounding electrodes, and requirements for the grounding electrode. See Figure A.

LIGHTNING — For added protection for this product during a lightning storm, or when it is left unattended and unused for long periods of time, unplug it from the wall outlet and disconnect the antenna or cable system. This will prevent damage to the product due to lightning and power-line surges.

POWER LINES — An outside antenna system should not be located in the vicinity of overhead power lines or other electric light or power circuits, or where it can fall into such power lines or circuits. When installing an outside antenna system, extreme care should be taken to keep from touching such power lines or circuits as contact with them might be fatal.

OVERLOADING — Do not overload wall outlets, extension cords, or integral convenience receptacles as this can result in a risk of fire or electric shock.

OBJECT AND LIQUID ENTRY — Never push objects of any kind into this product through openings as they may touch dangerous voltage points or short-out parts that could result in a fire or electric shock. Never spill liquid of any kind on the product.

SERVICING — Do not attempt to service this product yourself as opening or removing covers may expose you to dangerous voltage or other hazards. Refer all servicing to qualified service personnel.

DAMAGE REQUIRING SERVICE — Unplug this product from the wall outlet and refer servicing to qualified service personnel under the following conditions:

- When the power-supply cord or plug is damaged.
- If liquid has been spilled, or objects have fallen into the product.
- If the product has been exposed to rain or water.
- If the product does not operate normally by following the operating instructions. Adjust only those controls that are covered by the operating instructions as an improper adjustment of other controls may result in damage and will often require extensive work by a qualified technician to restore the product to its normal operation.
- If the product has been dropped or damaged in any way.
- When the product exhibits a distinct change in performance — this indicates a need for service.

REPLACEMENT PARTS — When replacement parts are required, be sure the service technician has used replacement parts specified by the manufacturer or have the same characteristics as the original part. Unauthorized substitutions may result in fire, electric shock, or other hazards.

SAFETY CHECK — Upon completion of any service or repairs to this product, ask the service technician to perform safety checks to determine that the product is in proper operating condition.

WALL OR CEILING MOUNTING — The product should not be mounted to a wall or ceiling.

HEAT — The product should be situated away from heat sources such as radiators, heat registers, stoves, or other products (including amplifiers) that produce heat.

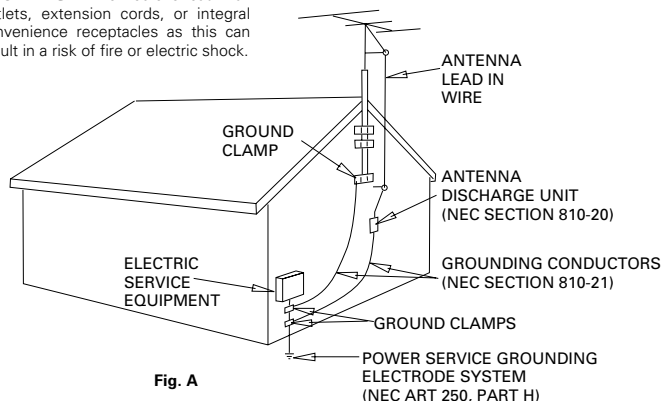

Fig. A



NEC — NATIONAL ELECTRICAL CODE

Features

DTS* (Digital Theater Systems) decoder equipped

DTS is a digital sound system introduced in theaters. Playback of DVD, LD, and CD recorded in DTS audio creates the environment of a theater or the sensation of a concert hall in your home.

Dolby** Digital and Dolby Pro Logic

No need to worry about program formats! When playing Dolby Digital or Dolby Pro Logic software in the  (Dolby) mode, decoding switches automatically according to the input signal. All you have to do is sit back and enjoy! (When connecting a DVD/LD player or LD player using the  RF (AC-3) output, a commercially available RF demodulator (RFD-1) is required.)

ADVANCED THEATER modes

Four sound modes that enhance DTS and Dolby audio performance by simulating the environment of a movie theater (DRAMA, ACTION), or the ambience of a concert hall (MUSICAL). With EXPANDED THEATER, you can enjoy Dolby Pro Logic encoded software in simulated Dolby Digital.

Various Surround Effects (DSP)

The DSP (Digital Signal Processing) surround mode allows you to transform your living room into six different sonic environments when listening to music or watching movies.

Midnight Listening Mode

When late night hours or other factors require that the volume be kept low, the surround effects may tend to become less than satisfactory. When the midnight listening mode is on, you can enjoy the effects of quality surround sound even at low volumes.

DVD 5.1 channel input

A special 5.1 Channel input makes the VSX-D309 fully compatible with Dolby Digital decoders and DVD players with 5.1 channel outputs.

The Energy-saving Design

This unit is designed to use minimal electricity when power is switched OFF (in Standby mode). Regarding the value of the power consumption in standby mode, refer to "Specifications" on pages 44.

Remote Control of Other Components

The supplied remote control can be used to operate a variety of other components simply by recalling the appropriate preset code. In addition, the multi-operation functions allow you to perform a variety of operations automatically.

**"DTS" and "DTS Digital Surround" are trademarks of Digital Theater Systems, Inc. Manufactured under licence from Digital Theater Systems, Inc.*

*** Manufactured under license from Dolby Laboratories. "Dolby", "Pro Logic" and double-D symbol are trademarks of Dolby Laboratories. Confidential unpublished works. © 1992-1997 Dolby Laboratories. All rights reserved.*

Features	4
Introductory Information	6
Checking the Supplied Accessories	6
Using this Manual	6
Installing the Receiver	6
When Making Cable Connections:	6
Preparing the Remote Control	7
Connecting Your System	8
Connecting Antennas	8
Connecting Audio Components	9
Connecting DVD 5.1 Channel Components	10
Connecting Video Components	10
Connecting Digital Components	11
Connecting Speakers	12
AC OUTLET [SWITCHED 100 W (0.8 A) MAX]	13
Preparations	14
Setting Up for Surround Sound	14
Setting the volume level of each channel	19
Setting Up the Remote Control	20
Clearing the Remote Control Settings	22
Direct Function	22
Displays & Controls	23
Front Panel	23
Display	24
Remote Control	25
Sound Modes	27
Learning about the Sound Modes	27
Switching ANALOG/DIGITAL Signal Input	28
Playing a Source	28
Playing Sources with Dolby Digital or DTS Sound	29
Selecting a Sound Mode	30
Using in MIDNIGHT Listening Mode	31
Using the Tuner	32
Finding a Station	32
Tuning Directly to a Station	33
Memorizing Stations	33
Recalling Memorized Stations	34
Making a Recording	35
Making an Audio or a Video Recording	35
Controlling the Rest of Your System	36
CD / MD / CD-R / VCR / LD Player Controls	36
Cassette Deck Controls	37
DVD / DVR Player Controls	38
DTV Controls	39
Cable TV / Satellite TV / TV Controls	40
Additional Information	41
Troubleshooting	41
Preset Code List	43
Specifications	44

Checking the Supplied Accessories

Please check that you've received the following supplied accessories:

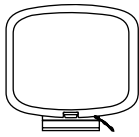

AM loop antenna



FM wire antenna

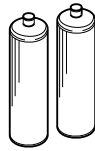

AA size IEC R6P
batteries (x2)

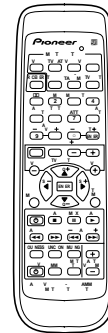

Remote control unit

Using this Manual

This manual is for the VSX-D309 audio/video multi-channel receiver. It is divided into two main sections:

Set up

This section covers installing your receiver and connecting up all the other components in your home theater system to it. It also describes how to set up a multi-channel speaker system to take full advantage of the great surround sound features of your receiver.

Operation

This section shows you how to use every feature of the receiver and its remote control unit. It also covers using the supplied remote control to operate your other home theater components. To find out more about a specific button, control or indicator, see Displays & Controls starting on page 23. This will point you to the relevant chapter in the manual. In the Additional Information section (p.41-44) you'll find a troubleshooting section and specifications.

The following symbols are used throughout this manual:



Provides detailed precautions and advice on operations, etc.



Indicates that display is blinking.

Installing the Receiver

Please note:

- Do not place objects directly on top of this unit. This would prevent proper heat dispersal.
- When installing in a rack, shelf, etc., be sure to leave more than 8 inches of space above the receiver.

8 inches (20 cm.)

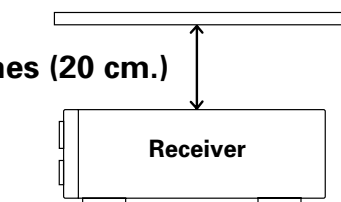

When Making Cable Connections:

Be careful not to arrange cables in a manner that bends the cables over the top of this unit as shown in the illustration. If the cables are brought over this unit, the magnetic field produced by the transformers in this unit may cause a humming noise to come from the speakers.

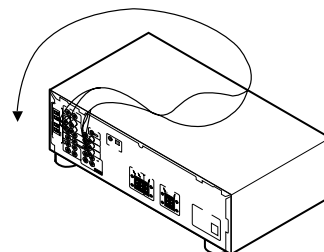

Preparing the Remote Control

Loading the batteries

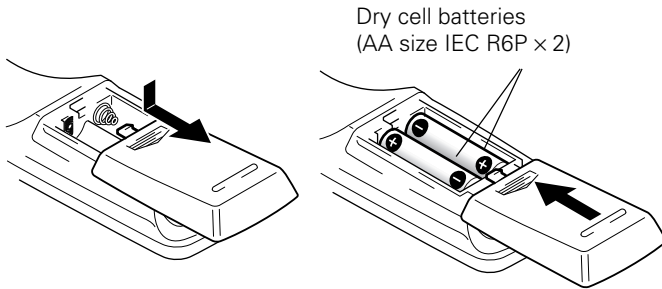

Dry cell batteries
(AA size IEC R6P × 2)

CAUTION!

Incorrect use of batteries may result in such hazards as leakage and bursting. Observe the following precautions:

- Never use new and old batteries together.
- Insert the plus and minus sides of the batteries properly according to the marks in the battery case.
- Batteries with the same shape may have different voltages. Do not use different batteries together.

Operating range of remote control unit



The remote control may not work properly if:

- There are obstacles between the remote control and the receiver's remote sensor.
- Direct sunlight or fluorescent light is shining onto the remote sensor.
- The receiver is located near a device that is emitting infrared rays.
- The receiver is operated simultaneously with another infrared remote control unit.

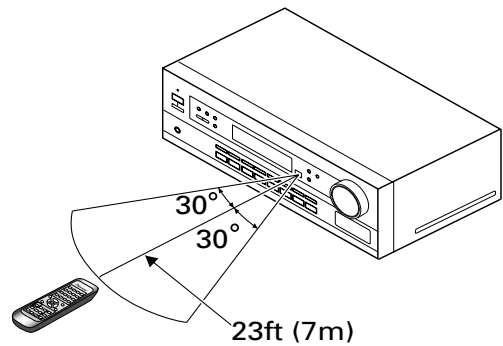

Operating other Pioneer components

By connecting a control cord (optional), you can control other Pioneer equipment using this remote control unit. Point the remote control unit towards the remote sensor of this unit, even when operating other equipment.

The remote control signals are received by the remote sensor of this unit, and sent to the other devices via the **CONTROL OUT** terminal.



You can also control Pioneer components by pointing the receiver's remote control directly at the component. This type of operation does not require control cords.

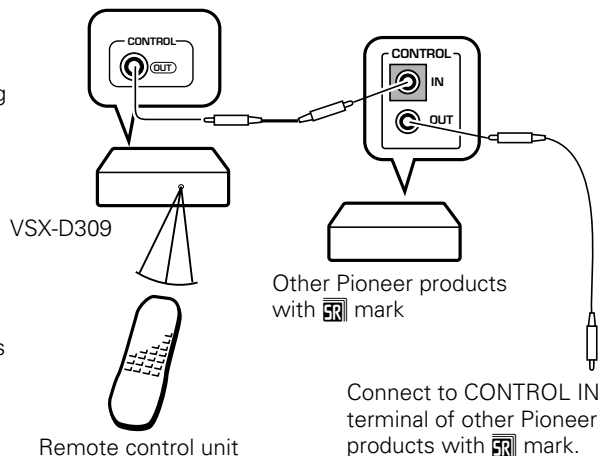

VSX-D309

Other Pioneer products with mark

Remote control unit

Connect to CONTROL IN terminal of other Pioneer products with mark.

Connecting Your System

Connecting Antennas

Connect the AM loop antenna and the FM wire antenna as shown below. To improve reception and sound quality, connect external antennas (see Using external antennas, below). Always make sure that the receiver is switched off and unplugged from the wall outlet before making any connections.

AM loop antenna

Assemble the antenna and connect to the receiver. Attach to a wall, etc. (if desired) and face in the direction that gives the best reception.

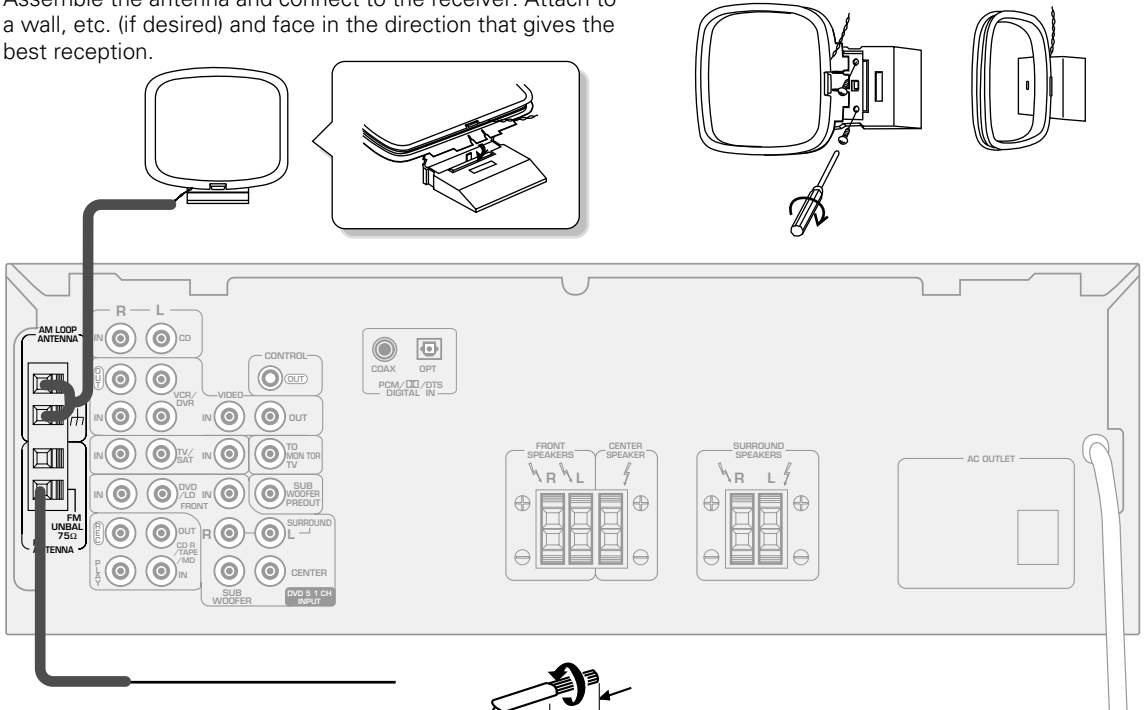

FM wire antenna

Connect the FM wire antenna and fully extend vertically along a window frame or other suitable area, etc.

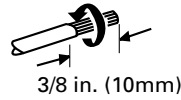

Antenna snap connectors

Twist the exposed wire strands together and insert into the hole, then snap the connector shut.

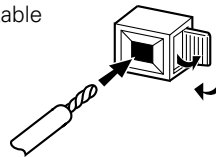

Using external antennas

■ To improve FM reception

Connect an external FM antenna.

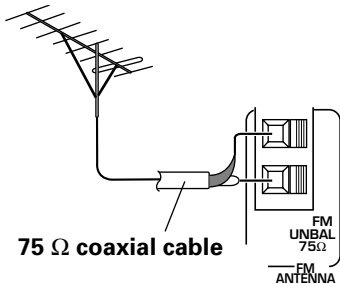

■ To improve AM reception

Connect a 15-18 feet length of vinyl-coated wire to the AM antenna terminal without disconnecting the supplied AM loop antenna. For the best possible reception, suspend horizontally outdoors.

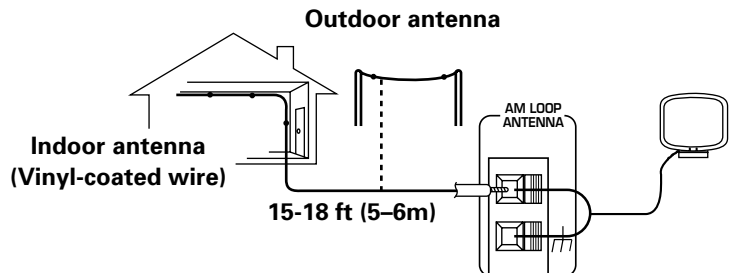

Connecting Audio Components

Connect your audio components as shown below. These are analog connections. When connecting equipment, always make sure the power switched off and the power cord is disconnected from the wall outlet.

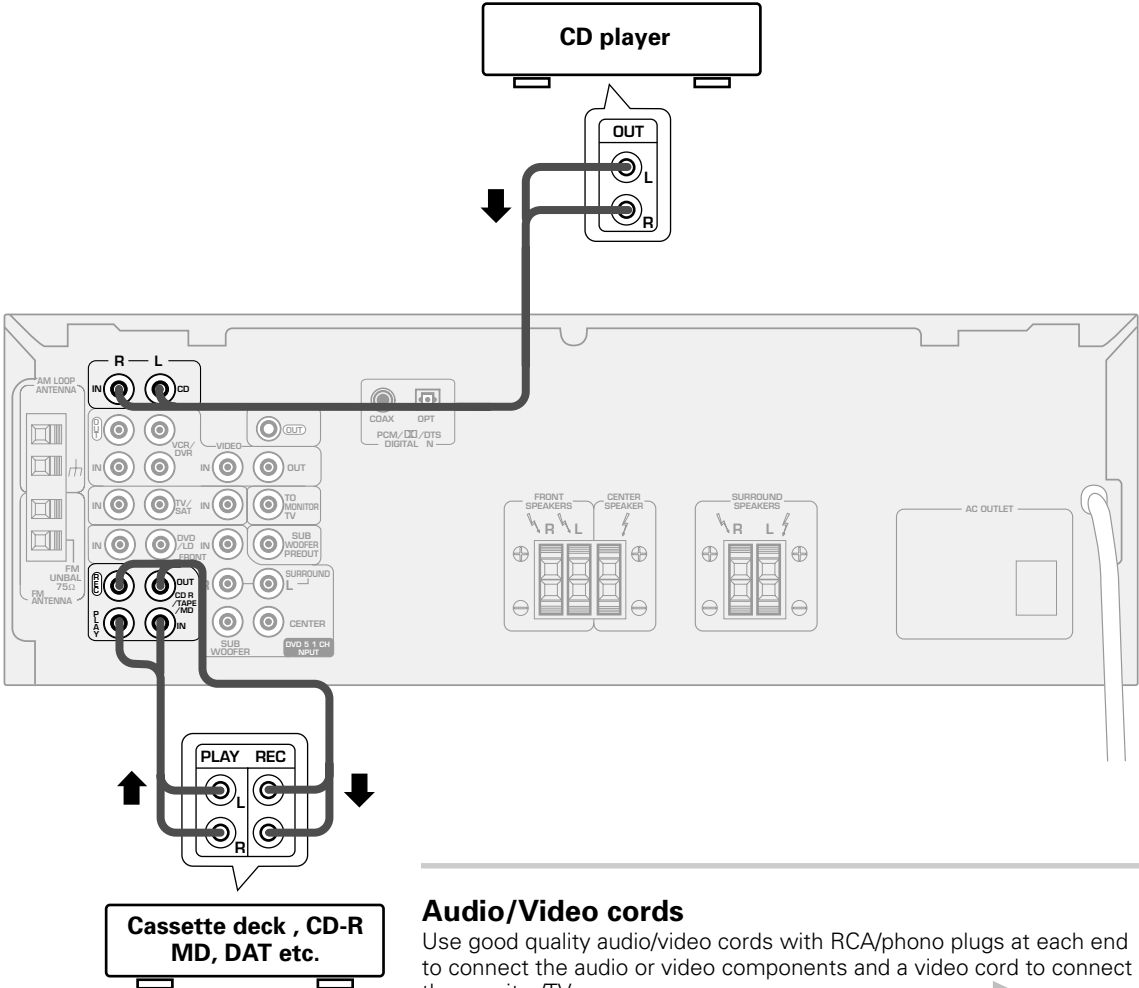

Audio/Video cords

Use good quality audio/video cords with RCA/phono plugs at each end to connect the audio or video components and a video cord to connect the monitor/TV.

Connect red plugs to R (right), white plugs to L (left), and the yellow plugs to VIDEO.

Be sure to push home the plugs into their sockets.

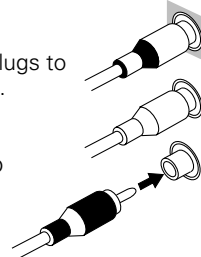

Cassette deck placement

Depending on where the cassette deck is placed, noise caused by leakage flux from the transformer in the receiver may occur during playback. If you experience noise, move the cassette deck farther away from the receiver.

Connecting DVD 5.1 Channel Components

DVD and LD discs are compatible with both 2 channel and 5.1 channel audio output formats. Connections can be made from a DVD player, multi-channel decoder equipped with 5.1 analog outputs to the 5.1 analog inputs on this unit. Always make sure that the receiver is switched off and unplugged from the wall outlet before making or changing any connections.

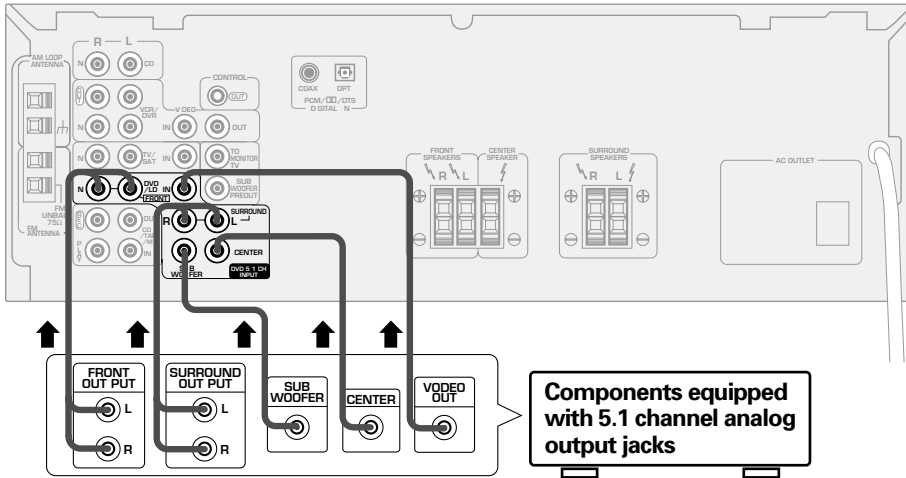

The 5.1 channel input can only be used when DVD 5.1 CH is selected.

Connecting Video Components

Connect your video components as shown below. When connecting equipment, make sure the power is switched off and the power cord disconnected from the wall outlet.

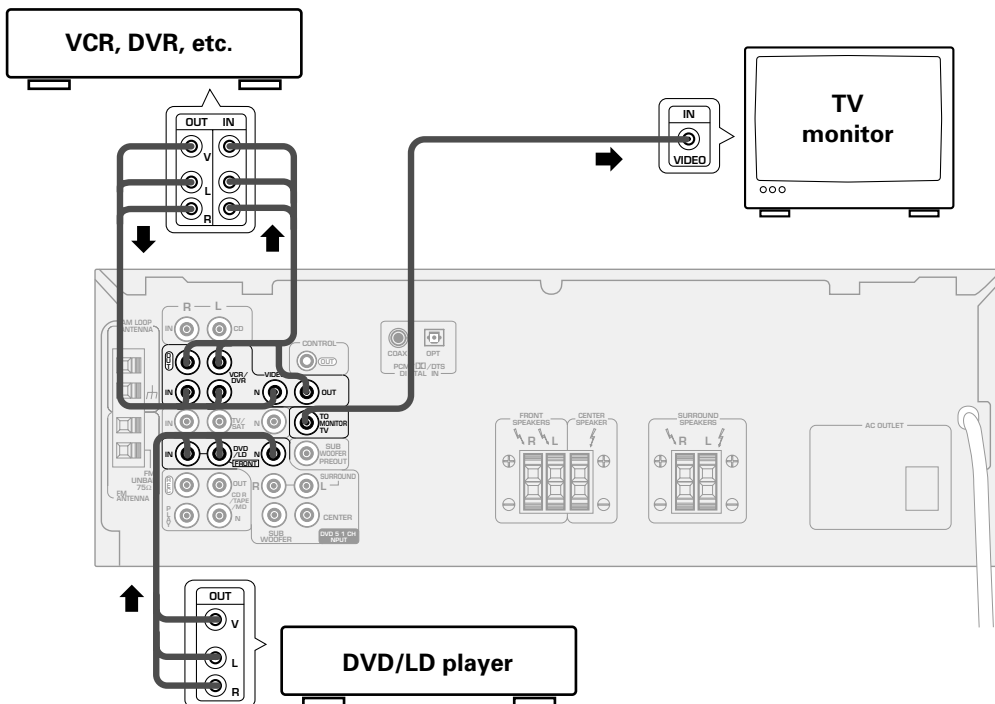

Connecting Digital Components

You can connect your audio and video equipment that have digital outputs by either digital or analog hook ups (you don't need to do both). In order to use DVDs with Dolby Digital/DTS soundtracks you need to make either digital audio connections or 5.1 channel analog connections (see facing page) from your DVD player. You can make digital connections by using either coaxial or optical cords (you don't need to use both). The quality of these two types of connections is the same but since some digital components only have one type of digital terminal, it is a matter of matching like with like (for example, the coaxial out from the component to coaxial in on the receiver). The VSX-D309 has one coaxial and one optical input for a total of two digital inputs. You can use either for any type of digital component (DVD, CD, CD-R, etc.). The diagram below just gives examples of possible connections.

Always make sure that the receiver is switched off and unplugged from the wall outlet before making or changing any connections.

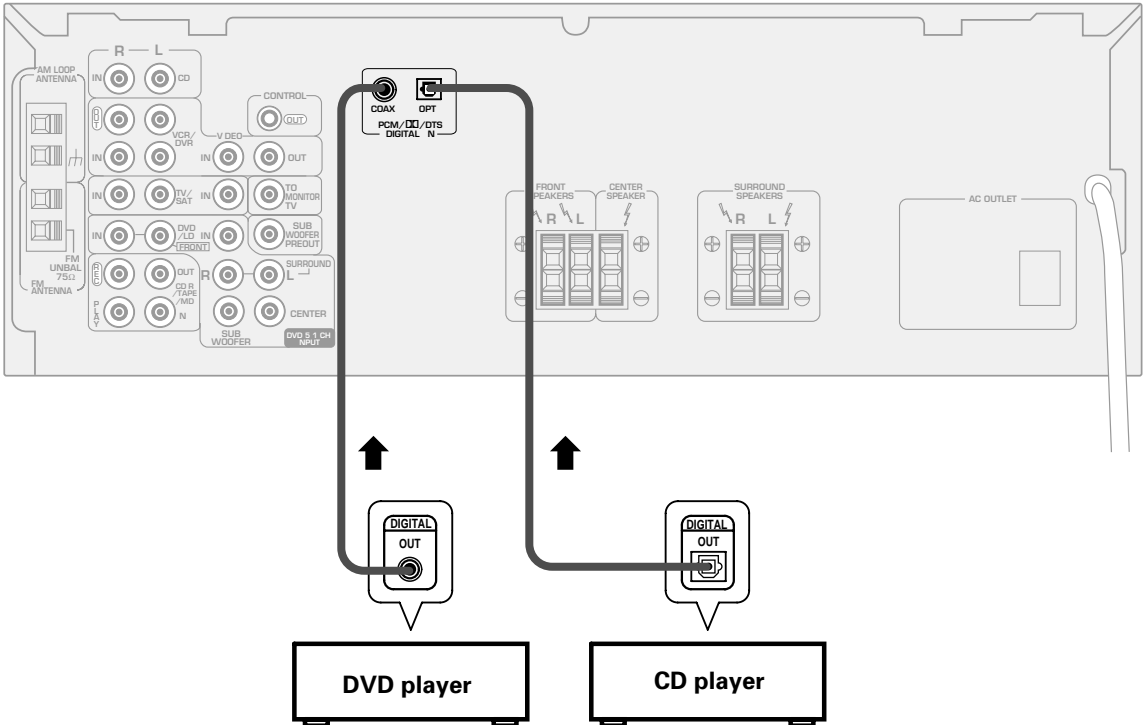

■ Digital audio cords/Optical cables

Commercially available digital audio coaxial cords (standard video cords can also be used) or optical cables (not supplied) are used to connect digital components to this receiver. When you use optical digital input or output terminals, pull off the caps and insert the plugs. Be sure to insert completely.

Digital audio cord (or standard video cord)

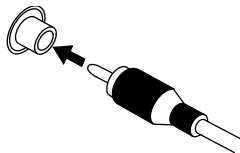

Optical cable

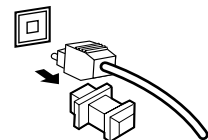

Connecting Speakers

Connect your speakers as shown below. Be sure to connect each speaker to the appropriate speaker terminal, and also to connect the positive and negative terminals correctly (so that the same wire is connected to the positive terminal of the receiver and the positive terminal of the speaker, and likewise with the negative). When connecting equipment, always make sure the power switched off and the power cord is disconnected from the wall outlet.

- Use speakers with a nominal impedance of 8 Ω to 16 Ω.

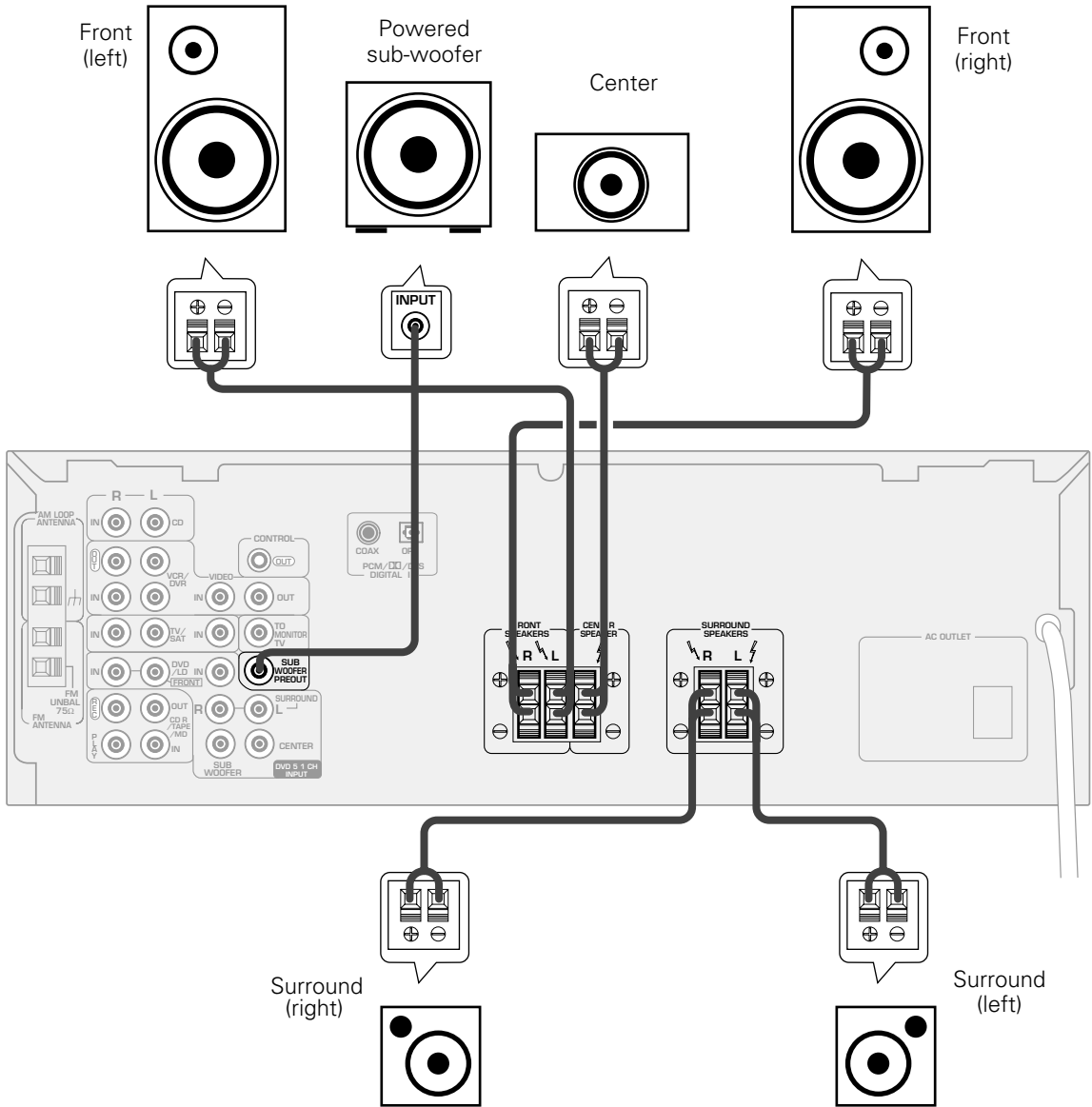

Speaker terminals

Use good quality speaker wire to connect the speakers to the receiver.

- ① Twist around 1/2 inch of bare wire strands together.
- ② Unclip the speaker terminal and insert the wire.
- ③ Snap shut the speaker terminal to secure.

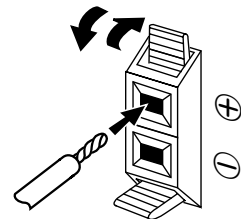

Hints on speaker placement

Speakers are usually designed with a particular placement in mind. Some are designed to be floorstanding, while others should be placed on stands to sound their best. Some should be placed near a wall; others should be placed away from walls. Follow the guidelines on placement that the speaker manufacturer provided with your particular speakers to get the most out of them.

- Place the front left and right speakers at equal distances from the TV.
- When placing speakers near the TV, we recommend using magnetically shielded speakers to prevent possible interference, such as discoloration of the picture when the TV is switched on. If you do not have magnetically shielded speakers and notice discoloration of the TV picture, move the speakers farther away from the TV.
- Install the center speaker above or below the TV so that the sound of the center channel is localized at the TV screen.

CAUTION!

If you choose to install the center speaker on top of the TV, be sure to secure it with putty, or by other suitable means, to reduce the risk of damage or injury resulting from the speaker falling from the TV in the event of external shocks such as earthquakes.

- If possible, install the surround speakers slightly above ear level.
- Try not to install the surround speakers farther away from the listening position than the front and center speakers. Doing so can weaken the surround sound effect.

To achieve the best possible surround sound, install your speakers as shown below. Be sure all speakers are installed securely to prevent accidents and improve sound quality.

Overhead view of speaker set up

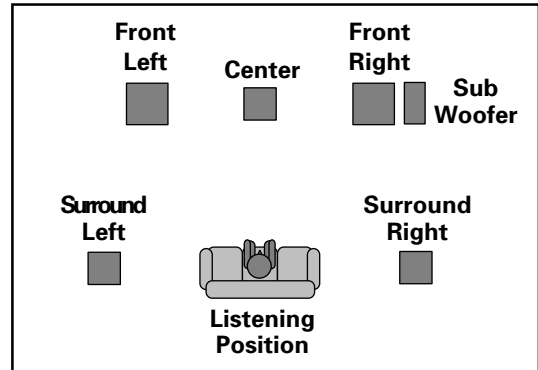

3-D view of speaker set up

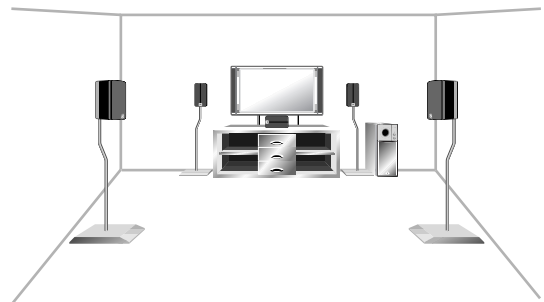

AC OUTLET [SWITCHED 100 W (0.8 A) MAX]

Power supplied through this outlet is turned on and off by the receiver's POWER switch.

Total electrical power consumption of connected equipment should not exceed 100 W (0.8 A).

Do not connect a heater, TV, etc.



- This unit should be disconnected by removing the power plug from the wall socket when not in regular use, e.g., on vacation.
- Do not connect appliances with high power consumption such as heaters, irons, or television sets to this AC OUTLET in order to avoid overheating and fire risk. This can also cause the receiver to malfunction.

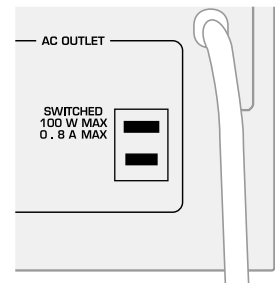

CAUTION:
DO NOT CONNECT A MONITOR OR TV SET TO THIS UNIT'S AC OUTLET.

Setting Up for Surround Sound

Be sure to switch the power of this unit on (The STANDBY indicator goes out).

To ensure the best possible surround sound, be sure to complete the following set up operations. This is particularly important when using the **DD** (Dolby/DTS) sound mode. You only need to make these settings once (unless you change the placement of your current speaker system or add new speakers, etc.). Refer to the following pages for detailed descriptions of the settings available for each mode.

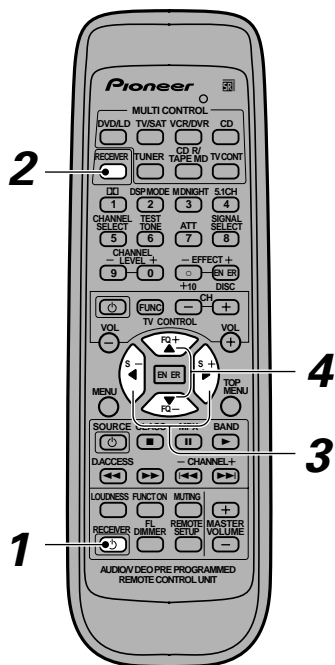

1 Press **RECEIVER** to turn the power on.

The STANDBY indicator goes out.

2 Press **REVERSE**.

This switches the remote to the surround setup mode.

3 Press **◀** or **▶** to select the mode you want to set.

For best results, start with "SPEAKER setting mode" and make your initial adjustments in the order described below.

The current settings are displayed automatically.

SPEAKERS (Front, Center, Surround) setting mode (page 15)

Use to specify the type of speakers you have connected.

SUB WOOFER ON/PLUS/OFF setting mode (page 16)

Use to specify the sub woofer as on or off.

Crossover frequency setting mode (page 16)

Use to determine which frequencies will be sent to the sub woofer (or "Large" speakers if you don't have a sub woofer).

LFE attenuator setting mode (page 16)

Use to specify the peak level for the LFE channel and the crossover network for rerouted bass frequencies.

Low cut filter ON/OFF setting mode (page 17)

Use to cut the distorted sound from the sub woofer.

FRONT speakers distance setting mode (page 17)

Use to specify the distance from your listening position to your front speaker.

CENTER speakers distance setting mode (page 17)

Use to specify the distance from your listening position to your center speaker.

SURROUND speakers distance setting mode (page 17)

Use to specify the distance from your listening position to your surround speakers.

Dynamic range control setting mode (page 18)

Use to compress the dynamic range of the sound track.

Dual mono setting (page 18)

Use with **DD** software that has dual mono encoding if you want to isolate one channel or listen in this specialized mono mode..

Coaxial digital input setting (page 18)

Use to specify the input to be assigned to the coaxial digital input.

Optical digital input setting (page 19)

Use to specify the input to be assigned to the optical digital input.

4 Press **△** or **▽** to select the setting you want to set.

The setting is entered automatically.

5 Repeat steps 3 and 4 to set other surround modes.



Press ENTER to exit the setting mode.

The setting mode is automatically exited if no operation is performed for 20 seconds.

SPEAKER (Front, Center, Surround) setting mode

This setting establishes the size and configuration of the speaker system you have connected. So, for example, here you set whether you have connected surround speakers or not, and how big they are. Selecting "Large" or "Small" will determine how much bass is sent by the receiver to the speakers being set. This setup system has certain constraints. For example, all your speakers cannot be set to "Large," you need to decide which speakers should receive the most bass and set them to "Large."

In the display, "F", "C", and "S" refer to front, center, and surround speakers respectively. Speaker size is denoted as "L" for large speakers, "S" for small speakers, and "*" (asterisk) if no speaker is connected.



If the cone size (radius) of the speaker is larger than 5 inches, please set to Large.

Switch the speaker setting mode according to the speakers you hooked up. Use the Δ or ∇ buttons.

The configurations shown on the right will appear in the display on the front of the receiver. One of them should match your speaker set up. Cycle through the different possibilities until you find the one that matches your set up.



* Press \triangleright to advance to the next receiver setting, and press \triangleleft to return to a previous receiver setting.

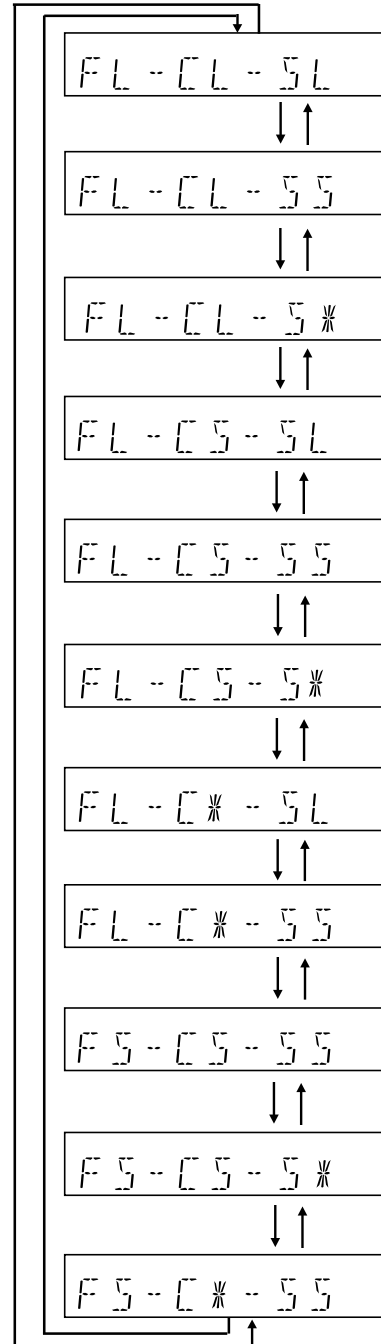

SUB WOOFER ON/PLUS/OFF setting mode

Sets whether the SUB WOOFER is used or not. Also, when used you have the option to use the "PLUS" setting.



- Initial setting is "ON".
- Setting the front speaker size to "Small" in the SPEAKER setting mode automatically locks the sub woofer in the "ON" position.
- Use the PLUS for extra bass. When you use PLUS you will get the bass sounds from the sub woofer even if the front speakers are set to "Large".

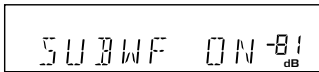

Press Δ or ∇ to select sub woofer ON, PLUS or OFF.

Crossover frequency setting mode

Crossover frequency is the point where the receiver divides the high and low sounds (the frequencies) between the speakers. Since most smaller speakers can't handle deep bass tones, this setting allows you to send those sounds to the sub woofer (or speakers set to "Large" if you don't have a sub woofer) instead of the speakers set to "Small" in your system. Choose the point at which you want the frequency routed to the sub woofer (or "Large" speakers).

We recommend setting this to 200 Hz if smaller bookshelf-type speakers are used for your "Small" speakers.



- Initial setting is "100 Hz".
- If all speakers (front, center, and surround) are set to "Large" in SPEAKER setting mode, crossover frequency cannot be set because there are no "Small" speakers (***) appears in the display).

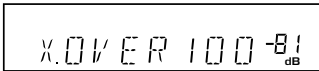

Press Δ or ∇ to specify the crossover frequency for your small speakers (100 Hz, 150 Hz or 200 Hz).

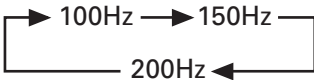

100 Hz

Sends bass frequencies below 100 Hz to the sub woofer (or "Large" speakers).

150 Hz

Sends bass frequencies below 150 Hz to the sub woofer (or "Large" speakers).

200 Hz

Sends bass frequencies below 200 Hz to the sub woofer (or "Large" speakers).

LFE attenuator setting mode

Dolby Digital and DTS audio sources include ultra-low bass tones. Set the LFE attenuator as needed to prevent the ultra-low bass tones from distorting the sound from the speakers.



- Initial setting is "0 dB".
- When ∞ is selected (** appears in the display), LFE is not available.

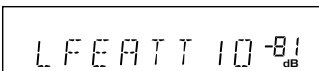

Press Δ or ∇ to set the attenuation level (0 dB, 10 dB or ** dB(∞)).



Low cut filter ON/OFF setting mode

Turn the low cut filter ON when distorted sound is output through the sub woofer.



- Initial setting is "OFF".
- If the SUB WOOFER is set to "OFF" in the SUB WOOFER ON/OFF setting mode, the low cut filter cannot be set.

L C F O N -81_{dB}

Press Δ or ∇ to select low cut filter ON or OFF.

FRONT speakers distance setting mode

Sets the distance from the FRONT speakers to the listening position.



- Initial setting is 10 ft.
- One step equals about 1ft.

F R T 10 f t. -81_{dB}

Press Δ or ∇ to set the distance of the FRONT speakers from the main listening position (up to 30 steps).

CENTER speaker distance setting mode

Normally as the Center speaker is placed directly in front in the listening room, it is closer to the listening position than the Front speakers. This means that the sound from the Center speaker will be heard before the Front speakers. To prevent this, set the Center speaker distance setting to delay the sound from the Center speaker so that the sound from the Front and Center speakers will be heard at the same time.



- Initial setting is 10 ft.
- When "C*" is selected in SPEAKER setting mode, the Center distance cannot be set.
- One step equals about 1 ft.

C N T 10 f t. -81_{dB}

Press Δ or ∇ to set the distance of the CENTER speaker from the main listening position (up to 30 steps).

SURROUND speakers distance setting mode

Use to set the SURROUND speakers distance. Like the CENTER speaker position, the SURROUND speakers may be set in a location closer or farther than the FRONT speakers. Set the distance of the SURROUND speakers accurately to hear sounds coming from both FRONT and SURROUND speakers at the same time.



- Initial setting is 10 ft.
- When "S*" is selected in SPEAKER setting mode, the SURROUND distance cannot be set.
- One step equals about 1 ft.

S U R 10 f t. -81_{dB}

Press Δ or ∇ to set the distance of the SURROUND speakers from the main listening position (up to 30 steps).

Dynamic range control setting mode

Dynamic range is the difference between the loudest and softest sounds in any given signal. The dynamic range control helps you play back sounds so the quieter sounds are audible yet the louder sounds don't get distorted. It does this by compressing the dynamic range. When watching a movie at low volume, setting this function enables low level sounds to be heard more easily but you won't be jolted by louder sounds.



- Initial setting is "OFF".
- When the volume level is increased, set to OFF.
- For listening enjoyment at low volumes, set to "MAX" for maximum dynamic range compression.
- Dynamic range control is effective only when a Dolby Digital signal is being played back.

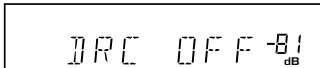

Press Δ or ∇ to set the dynamic range control (OFF, MAX, or MID).

Dual mono setting

The dual mono setting can only be used when listening to Dolby Digital discs that have dual mono software encoded in them. With this setting you can choose which channel in the dual mono setting you want to listen to. Thus, it is useful for soundtracks that have one language on one channel and a different language on the other. Remember you can only use this setting if you have Dolby Digital software with this feature and want to isolate one of the channels therein. Otherwise, just ignore this function.

There are two different ways to route the sound in the dual mono setting, one is with Dolby Digital on, the other with Dolby Digital off. If Dolby Digital is switched on, the ch1 setting will play ch1 through your center speaker. The ch2 setting will play ch2 through your center speaker and the MIX setting will play both channels through the center speaker. With Dolby Digital off, the dual mono sound routing is as follows: In the ch1 setting you will hear channel 1 out of both front speakers. In the ch2 setting you will hear channel 2 out of both speakers. In the L. c1 R. c2 setting the speakers will play the soundtrack independently of each other. The left front speaker will play channel 1 and the right front speaker will play channel 2. The last setting, MIX, mixes both channels and plays them out of both speakers.



- The default setting of this feature is L C 1 R C 2.

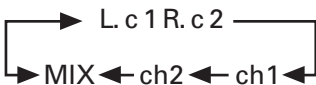

Press Δ or ∇ to cycle through the possible DUAL MONO settings.

Coaxial digital input setting

Sets the input component to be assigned to the coaxial digital input jack.



- Initial setting is "DVD".

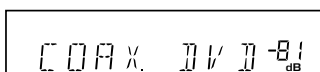

Press Δ or ∇ to select the coaxial digital input (DVD, TV, CD, CD-R, VCR, DV-R or OFF).

After you assign the component to a digital jack, like coaxial one, whenever you select that component, for example CD, the receiver will automatically change to the digital input setting. You can see this in the DIGITAL/ANALOG indicator on the front of the receiver.

Optical digital input setting

Sets the input component to be assigned to the optical input jack.



- Initial setting is "CD".

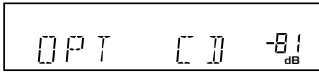

Press Δ or ∇ to select the optical digital input 1 (DVD, TV, CD, CD-R, VCR, or OFF).

After you assign the component to a digital jack, like optical one, whenever you select that component, for example CD, the receiver will automatically change to the digital input setting. You can see this in the DIGITAL/ANALOG indicator on the front of the receiver.

Setting the volume level of each channel (Adjusting the speaker volume balance)



- Since the SUB WOOFER transmits an ultra-low frequency its sound may seem quieter than it actually is.
- The speaker volume can be adjusted without outputting the test tone by pressing CHANNEL LEVEL or CHANNEL SELECT.
- Initial setting is 0 dB.

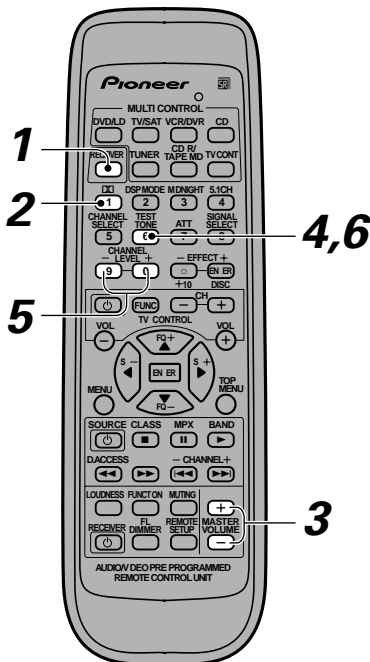

1 Press RECEIVER.

2 Press \square .

3 Press VOL + or - to adjust the volume to an appropriate level.

4 Press TEST TONE to output the test tone.

The test tone is output in the following order.

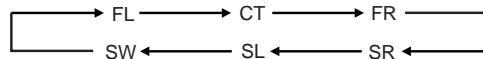

- Test tone is only output in Dolby/DTS modes.

5 Adjust speaker levels so that you hear the test tone at the same volume from each speaker when seated in the main listening position.

The channel level ranges ± 10 dB.



- Levels can be set for each surround mode.
- The CH. LEVEL and CH. SELECT buttons can be used to set levels even when the TEST TONE is not employed.
- The initial setting is 0dB.
- The subwoofer test tone may seem softer than the actual sound.

6 Press TEST TONE to turn off the test tone.

Setting Up the Remote Control

In addition to controlling the receiver, the supplied remote control can operate your other components (DVD, MD, VCR, TV, LD, CD, etc.). If your component(s) are listed in the "Preset Code List" on page 43, simply recall the corresponding preset code.

Recalling preset codes

The following steps show you how to recall preset codes for each MULTI CONTROL button. Once the preset code is assigned, pressing the button will automatically set the remote to operate the respective component.



- Refer to "Preset Code List" on page 43 for the components and manufacturers available.
- Refer to "Controlling the Rest of Your System" on pages 36 to 40 for detailed explanations on how to operate your other components.

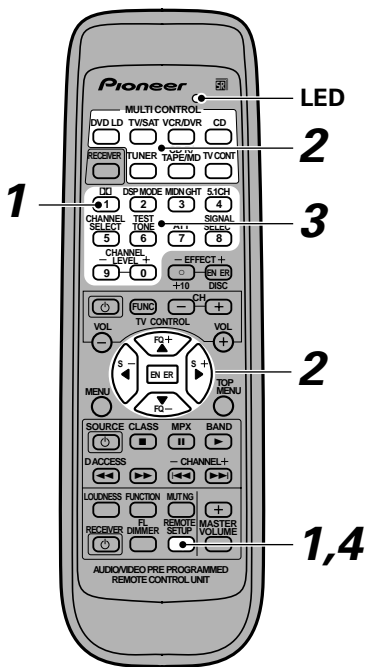

1 Press REMOTE SET UP and 1 at the same time to select the preset mode.

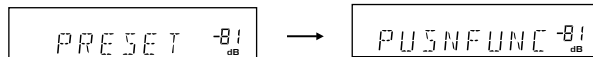

The LED on the remote control starts to blink.

To cancel the preset mode at any time
Press REMOTE SET UP.

2 Press the MULTI CONTROL button for the component you want to control.

Each button can be set to control one of the following components

DVD/LD	:	DVD or LD player
TV/SAT	:	TV or Satellite tuner
VCR/DVR	:	VCR or Digital Video Recorder
CD	:	CD player
CD-R/TAPE/MD	:	CD Recorder or Tape deck or MD player
TV/CONT	:	TV or Cable TV tuner

The LED lights steadily and the first manufacturer (and preset code(s)) appear in the display.

If no commands are entered the receiver automatically exits the preset code mode after 20 seconds.

3 Press Δ or ∇ repeatedly to display the name of the component's manufacturer.

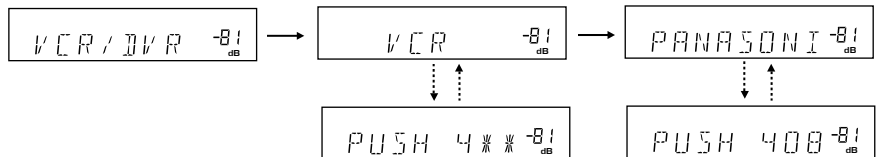

If necessary, press \triangleleft or \triangleright to see if an alternative code from the same manufacturer is available.

A list of all available preset codes is provided on page 43.

If no commands are entered the receiver automatically exits the preset code mode after 20 seconds.

4 Point the remote toward the component to be controlled, enter the 3 digit setup code.

When you enter the setup code, the remote emits a power ON/OFF signal. If the component turns ON or OFF, you have entered the proper code.

If the component does not turn ON or OFF and there is more than one setup code, press <L> or <R> to select another code in step 3 or try inputting another code (starting again from step 2). Some manufacturers use several sets of remote control signals and the first code may not correspond to your component.

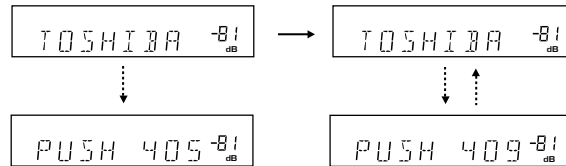

Repeat steps 2 through 4 to assign preset codes for as many components as necessary.

5 Press REMOTE SET UP to exit the preset mode.

The remote control returns to the previous operation mode.

- When operating a PIONEER'S DVD/LD player, set the manufacturer code to "111" in the preset mode.
- All codes enrolled in the manufacturer code list can be set even if a code is not displayed.
- TUNER cannot be preset.
- If no commands are entered the receiver automatically exits the preset code mode after 20 seconds.

Clearing the Remote Control Settings

Clears all presets and restores factory default settings.

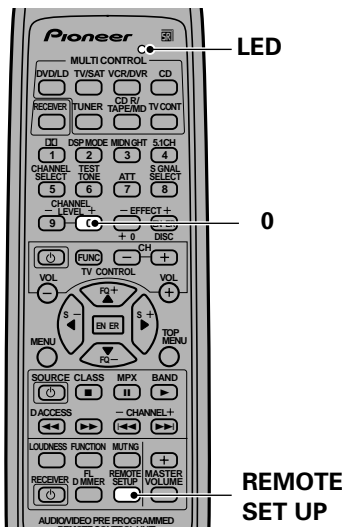

Press REMOTE SET UP and 0 at the same time for more 3 seconds.

The LED display at the top of the remote control will blink. After blinking three times, all the settings will be canceled.

Direct Function

The direct function is a useful feature which allows you keep the receiver in one function (for example, CD) while putting the remote control in a different function. This could let you, for example, use the remote control to set up and listen to a CD on the receiver and then use the remote control to rewind a tape in your VCR while you continue to listen to your CD player.

When the DIRECT function is ON any MULTI CONTROL button you press will change the function of both the receiver and the remote control. When you turn the DIRECT function OFF, you can operate the remote control without effecting the receiver. Thus you could switch the remote control the VCR and operate that component while the receiver plays a different component.

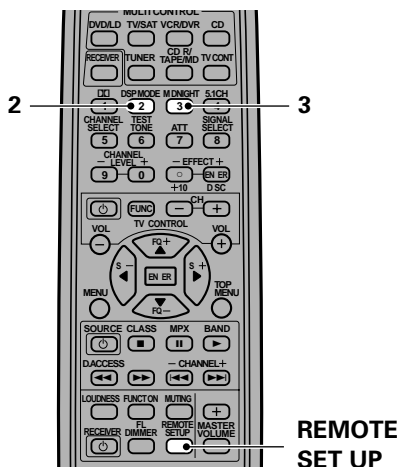

1 To turn the DIRECT function OFF (the default setting is ON), press REMOTE SET UP and number button 3 at the same time.

2 To turn the the DIRECT function ON (if you have turned it off), press REMOTE SET UP and number button 2 at the same time.

Front Panel

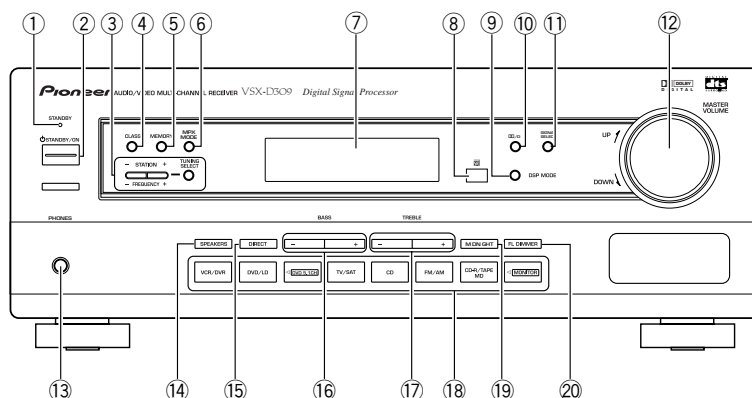

- ① **STANDBY indicator**
Lights when the receiver is in standby mode (note that the receiver consumes a small amount of power (1W) in standby mode).
- ② **STANDBY/ON button**
Switches the receiver between on and standby.(note that the receiver consumes a small amount of power (1W) in standby mode).
- ③ **STATION (+/-), FREQUENCY (+/-), TUNING SELECT buttons (see pages 32–34)**
STATION (+/-)
Selects station memories when using the tuner.
FREQUENCY (+/-)
Selects the frequency when using the tuner.
TUNING SELECT
Switches between station memory and frequency select modes.
- ④ **CLASS button (see pages 33-34)**
Switches between the three banks (classes) of station memories.
- ⑤ **MEMORY button (see page 34)**
Press to memorize a station for recall using the STATION (+/-) buttons.
- ⑥ **MPX button (see page 32)**
If the **TUNED** or **STEREO** indicators don't light when tuning to an FM station because the signal is weak, press the MPX button to switch the receiver into mono reception mode. This should improve the sound quality and allow you to enjoy the broadcast.
- ⑦ **Display (see page 24)**
- ⑧ **Remote sensor**
Receives the signals from the remote control.
- ⑨ **DSP MODE button (see page 30)**
Use to switch between the various DSP modes available (**HALL1, HALL 2, JAZZ, DANCE, THEATER1, THEATER 2**) and **DSP off**. Use to create different surround sound effects from any stereo source.
- ⑩ **Dolby/DTS button (see pages 29, 31)**
Use to switch between the various Dolby/DTS surround modes.
- ⑪ **SIGNAL SELECT button (see page 28)**
Use to select between an analog or digital signal.
- ⑫ **MASTER VOLUME**
Use to set the overall listening volume.
- ⑬ **PHONES jack**
Use to connect headphones but this does not switch the speakers off.
- ⑭ **SPEAKER button**
Use to switch the speaker system on or off.
- ⑮ **DIRECT button**
Use to switch DIRECT playback on or off. This mode bypasses the tone controls and channel levels for the most accurate reproduction of a program source.
- ⑯ **BASS (+/-) buttons**
Use to increase/decrease bass (within a range of -6dB to 6dB in 2dB steps).
- ⑰ **TREBLE (+/-) buttons**
Use to increase/decrease treble (within a range of -6dB to 6dB in 2dB steps).
- ⑱ **Function buttons**
Use to select a source for playback or recording.
- ⑲ **MIDNIGHT button (see page 31)**
Use when listening to movie soundtracks at low volume. This feature will enable you to hear quiet sounds and not get jolted by loud or sudden sound effects.
- ⑳ **FL DIMMER button**
Use this button to make the fluorescent display (FL) dimmer or brighter. There are three brightness settings as well as an off setting.

Display

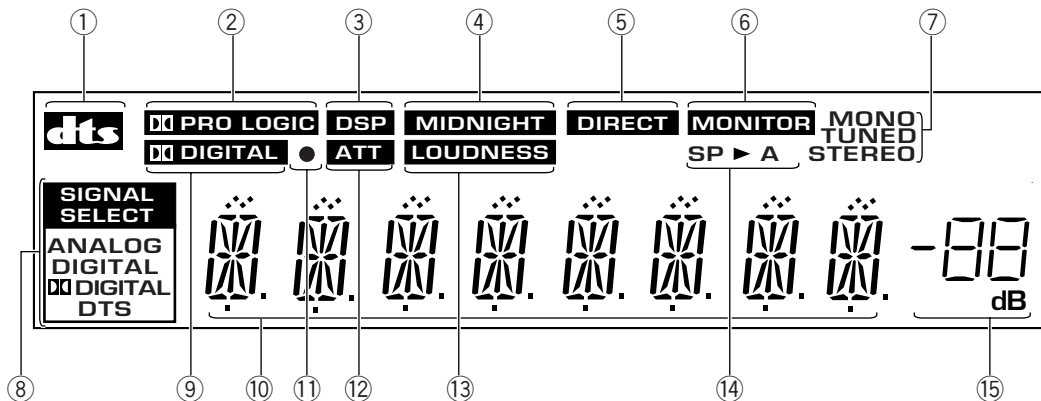

- ① **DTS indicator**
Lights when DTS mode is being used.
- ② **PRO LOGIC indicator**
When the **PRO LOGIC** Surround/DTS mode of the receiver is on, this lights to indicate playback of a two channel source.
- ③ **DSP indicator**
Lights when any Advanced Theater or DSP mode is selected.
- ④ **MIDNIGHT indicator**
Lights when MIDNIGHT listening mode is in use.
- ⑤ **DIRECT indicator**
Lights when source DIRECT is in use. This function bypasses all tone, balance, DSP and Dolby Surround effects.
- ⑥ **MONITOR indicator**
Lights when **MONITOR** is selected to hear a recording as it's being made (see page 35).
- ⑦ **TUNER indicators**
MONO:
Lights when the mono mode is set using the MPX MODE button.
TUNED:
Lights when a broadcast is being received.
STEREO:
Lights when a stereo FM broadcast is being received in auto stereo mode.
- ⑧ **SIGNAL SELECT indicators**
Light to indicate the type of input signal assigned for the current component (see "Front Panel", ①, SIGNAL SELECT).
ANALOG : Lights when an analog signal is selected.
DIGITAL : Lights when a digital audio signal is selected.
- ⑨ **DIGITAL indicator**
DIGITAL : Lights when a DOLBY DIGITAL signal is played.
DTS: Lights when a source with DTS audio signals is played.
- ⑩ **CHARACTER display**
Shows the radio frequency or function (DVD/LD, CD, etc.) receiver is using .
- ⑪ **OVERLOAD indicator**
This lights when an analog signal is too strong (the SIGNAL SELECT needs to be on ANALOG). It indicates the sound is distorting and the signal should be reduced.
- ⑫ **ATT indicator**
Lights when ATT is used to attenuate (reduce) the level of the input signal (can only be used in ANALOG mode).
- ⑬ **LOUDNESS indicator**
Lights when the LOUDNESS, used to boost the bass and treble in quiet listening, is on.
- ⑭ **SPEAKER indicator**
Shows if the speaker system is on or not. **SP ► A** means speakers are switched on. **SP ►** means speakers are switched off.
- ⑮ **MASTER VOLUME LEVEL**
Shows the overall volume level. Volume level is maintained even when the power is off. **-dB** indicates the minimum level, and **0dB** indicates the maximum level.
 - Depending on the level settings you make for individual channels, the MAX level can range between **-10dB** and **0dB**.

Remote Control

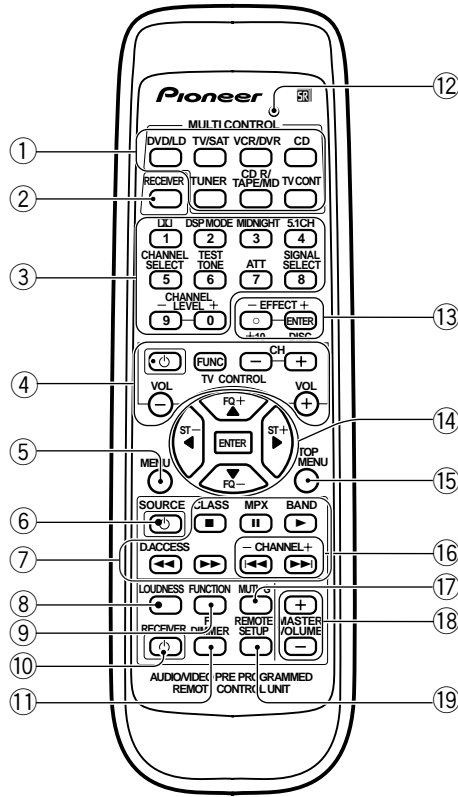

- ① **MULTI CONTROL buttons**
Use to put the receiver/remote control in the stated mode.
For other equipment controls, see Controlling the Rest of Your System on pages 36-40.
- ② **RECEIVER button (see page 14)**
Use this button when setting up the surround sound for the receiver.
- ③ **NUMBER/MODE buttons (see pages 33, 34)**
Use the number buttons to select the radio frequency in tuner DIRECT ACCESS mode or the tracks in CD, DVD mode etc.

Also, buttons marked with the following names have special functions. If you try to use one of these functions but the display flashes it means that function cannot be used in the current mode (for example DSP modes cannot be used when 5.1 CH setting is on).

DD (see pages 27, 29)

Use to put receiver in DOLBY DIGITAL and DTS modes. To use first press the RECEIVER button then operate this button.

DSP mode (see pages 27, 30)

Use to put receiver in one of the DSP modes. To use first press the RECEIVER button then operate this button.

MIDNIGHT (see page 31)

Use to put receiver in MIDNIGHT mode. To use first press the RECEIVER button then operate this button.

5.1 CH (see page 30)

When the DVD/LD or DVD 5.1 CH function is selected each press switches the DVD/LD input between DVD/LD and DVD 5.1 CH. To use first press the RECEIVER button then operate this button.

CHANNEL SELECT (see page 19-note)

Use to select a speaker when setting up the surround sound of the receiver. To use first press the RECEIVER button then operate this button.

TEST TONE (see page 19)

Use to sound the TEST TONE when setting up the surround sound of the receiver. To use first press the RECEIVER button then operate this button.

ATT

Use to attenuate (lower) the level of an analog input signal and prevent distortion (refer to p.24 ⑪, ⑫). To use first press the RECEIVER button then operate this button.

CHANNEL LEVEL +/- (see page 19-note)

Use to set up the levels of the surround sound of the receiver. To use first press the RECEIVER button then operate this button.

SIGNAL SELECT (see page 28)

Use to select the proper signal (analog, digital) for the source your are inputting. To use first press the RECEIVER button then operate this button.

④ THE FOLLOWING FOUR SETS OF BUTTONS ARE DEDICATED TV CONTROL. THEY ARE ONLY USED FOR CONTROLLING YOUR TV.

FUNC button

Use select the TV function.

TV POWER button

Use to turn on the power of the TV.

TV CHANNEL +/- buttons

Use to change channels on your TV.

TV VOLUME +/- buttons

Use to adjust the volume on your TV.

⑤ MENU button

Use to access different menus associated with your DVD player.

⑥ SOURCE button

Use to turn on/off other components connected to the receiver.

⑦ THE FOLLOWING BUTTONS ARE BOTH CONTROLS FOR OTHER COMPONENTS (LIKE A DVD PLAYER) AND DEDICATED TUNER CONTROLS. THE TUNER CONTROLS ARE EXPLAINED HERE. YOU CAN USE THEM AFTER YOU HAVE PUSHED THE TUNER MULTI CONTROL BUTTON.

CLASS button (see pages 33, 34)

Use to switch between the three banks (classes) of station memories.

MPX MODE button (see page 32)

Use to switch between auto stereo and mono reception of FM broadcasts. If the signal is weak then switching to MONO will improve the sound quality. Also, this is the pause button for CDs, tapes, DVDs, etc.

BAND button (see pages 32, 33)

Use to switch between the AM and FM band when in TUNER mode.

D. ACCESS button (see page 33)

Use to directly access a radio station by pressing the number of the station you want.

⑧ LOUDNESS button

Use to switch on the loudness. This feature is useful for getting good bass and treble sounds listening at low volumes.

⑨ FUNCTION button

Use select the playback or recording source. This button lets you cycle through the different functions of the receiver in the following order: CD, tuner, CDR/TAPE, VCDR/DVR, DVD/LD, DVD 5.1 CH., and TV/SAT. etc.

⑩ RECEIVER (POWER) button

This switches between STANDBY mode and power ON for this receiver.

⑪ FL DIMMER button

Use this button to make the fluorescent display (FL) dimmer or brighter. There are three brightness settings as well as an off setting.

⑫ LED DISPLAY (see pages 20-21)

This display flashes when a command is sent from the remote control to the receiver. It also flashes at other times, for example when teaching the receiver preset codes, with specific meanings.

⑬ EFFECT +/- buttons (see page 31-note)

Use to add or subtract the amount of effect in different DSP sound modes or advanced listening modes.

⑭ (FQ +/-) & ENTER buttons (see pages 14-15, 34)

Use these arrow buttons when setting up your surround sound system (see pages 14-15). These buttons are also used to control DVD menus/options and for deck 1 of a double cassette deck player. The FQ +/- buttons can be used to find radio frequencies.

⑮ TOP MENU button

In DVD mode this button brings you to the top or most fundamental menu.

⑯ CHANNEL +/- buttons

Use to select the stations of memorized radio frequencies. Also use to skip tracks backward or forward on CDs, DVDs, etc.

⑰ MUTING button

Use to mute the sound or restore the sound if it has been muted.

⑱ MASTER VOLUME +/- buttons

Use to set the overall listening volume.

⑲ REMOTE SETUP button (see pages 20, 21)

Use this button when setting up the remote control to control other components.

Learning about the Sound Modes

The sound modes are explained here.

There are two cinema modes: STANDARD, and ADVANCED THEATER. These are designed to be used with multi channel surround sound audio/visual sources (like DVDs and LDs). Intrinsic to home theater, these modes can deliver realistic and powerful surround sound that recreates the movie theater experience. You may need to experiment with them to see which settings suit your home system and personal tastes.

The DSP and STEREO modes are designed to be used with music sources but some DSP modes are also suited for film soundtracks. Again, try different settings with various soundtracks to see which you like.

STANDARD mode

This mode is for pure decoding of Dolby Digital, DTS and Dolby Surround. No special effects are added. It is good for enjoying movies that have been recorded in Dolby Digital, DTS or Dolby Surround.

ADVANCED THEATER modes

MUSICAL

Simulates the acoustic environment of a large concert hall and is suitable for music or musical sources

marked  () or .

DRAMA

Simulates the relaxed environment of a classic medium size movie theater, and is suitable for watching

dramas on sources marked  () or .

ACTION

Simulates the acoustic environment of a modern large movie theater. You can enjoy the power and dynamics of motion picture audio which is suitable for action movies on sources marked ,

 or .

EXPANDED

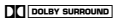
This mode is especially designed to give sound depth to stereo sources. The overall effect builds a dynamic and broad sound space, allowing two-channel (stereo) signals to faithfully imitate a five speaker sound. The mode should be used in conjunction with Dolby Pro Logic for sources bearing the  mark.

DSP modes

The DSP (Digital Signal Processing) modes allow you to transform your living room into a variety of different sonic environments when playing standard (two-channel) stereo sources, Dolby Pro Logic sources, and Dolby Digital sources. If you try to add this effect to functions which can not use it "SP off" flashes in the display.

HALL 1

Simulates the acoustic environment of a large concert hall of wooden construction. Complex delay of reflected sounds coupled with reverberation effects create a dynamic and beautiful sound characteristic of an orchestra performing in a concert hall, making it suitable for classical music

HALL 2

Simulates the acoustic environment of a concert hall with stone walls. The rich reverberations and natural fullness of the sound create the auditory impression of being in a concert hall, making it suitable for classical music.

JAZZ

Simulates the acoustic environment of a jazz club. Less delay on the reflected sounds emphasizes the sensation of hearing a live band.

DANCE

Simulates the acoustic environment and strong bass sound of a nightclub with a square dance floor. A short delay on the reflected sounds emulates the raw power of the dance music.

THEATER 1

Adjusts the delay of the reflected sound to simulate the acoustic environment of a medium sized movie theater.

THEATER 2

Simulates the acoustic environment of a theater while maintaining proper localization of each channel.

Switching ANALOG/DIGITAL Signal Input

Set this switch to tell the receiver whether you're using a component that is hooked up digitally or in an analog manner. If you have no components connected digitally the switch won't allow you to select digital.

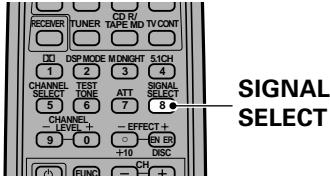

SIGNAL SELECT

1 Press SIGNAL SELECT to select the input signal corresponding to the source component.

Each press switches between ANALOG and DIGITAL signal selection.

Each press switches between ANALOG and DIGITAL signal selection.

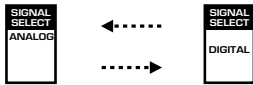

When a Dolby Digital signal is input.



When a DTS signal is input.



2 While SIGNAL SELECT is set to DIGITAL, **DD** DIGITAL lights when a Dolby Digital signal is input, **DTS** lights when a DTS signal is input.



- SIGNAL SELECT is fixed in the "ANALOG" position for components not assigned to one of the two digital input jacks.
- This receiver can only play back Dolby Digital, PCM (32kHz, 44kHz, and 48kHz), DTS, digital signal formats. With digital signal formats other than these, set SIGNAL SELECT to "ANALOG".
- When an LD or CD player compatible with DTS is played back with SIGNAL SELECT set in "ANALOG", digital noise is output caused by playing back the DTS directly (no decoding). To prevent noise, you need to make digital connections (Refer to page 11) and set SIGNAL SELECT to "DIGITAL".
- Some DVD players don't output DTS signals. For more details, refer to the instruction manual supplied with your DVD player.
- Audio from a karaoke microphone and some LDs are analog so set the SIGNAL SELECT to "ANALOG" in these cases.
- For analog LDs and karaoke microphones, set the switch to "ANALOG."

SIGNAL SELECT

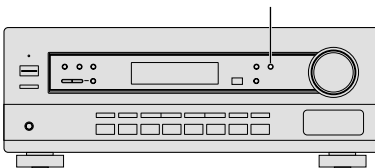

Playing a Source

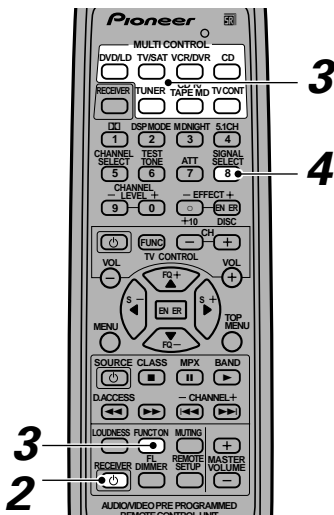

1 Turn on the power of the playback component.

2 Turn on the power of the receiver.

Be sure that the standby indicator turns off on the front panel.

3 Press MULTI CONTROL buttons or the FUNCTION button to select the source you want to playback.

If the DIRECT FUNCTION is OFF you have to use the FUNCTION button to select the source (see p.22).

4 If necessary, press SIGNAL SELECT to select the input signal corresponding to the source component (as above).

5 Start playback of the component you selected in step 1.

Playing Sources with Dolby Digital or DTS Sound

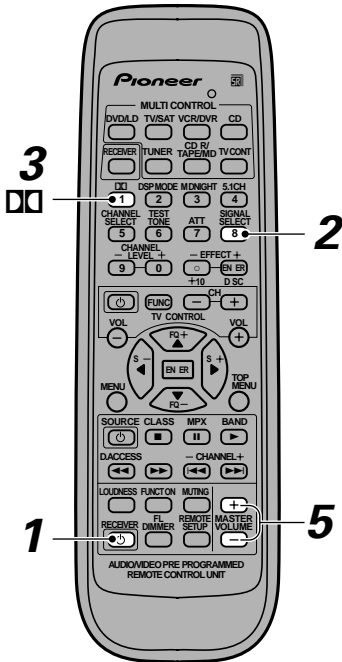

1 Follow steps 1 to 3 of the playback procedure. (Refer to “Playing a source” on the previous page.)

- ① Turn on the power of the playback component.
- ② Turn on the power of the receiver.
- ③ Press FUNCTION to select the source component you want to play.

2 Press SIGNAL SELECT to select DIGITAL.

(Refer to “Switching ANALOG/DIGITAL signal input” on the previous page.)

3 Press to switch the Dolby/DTS mode on.

4 Start playback of the component you selected in step 1.

5 Press MASTER VOLUME (+/-) to adjust the volume level.

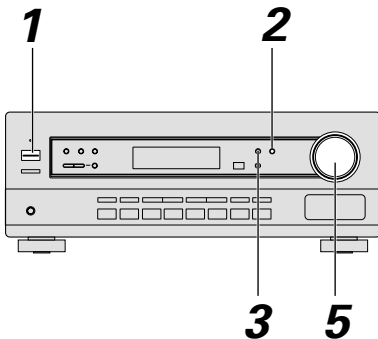

- When an LD or CD player compatible with DTS is played back with SIGNAL SELECT set in “ANALOG”, digital noise is output caused by playing back the DTS directly (no decoding). To prevent noise, you need to make digital connections (refer to pages 11) and set SIGNAL SELECT to “DIGITAL”.



When playing LD recorded in Dolby Digital

When connecting a DVD/LD player or LD player using the RF (AC-3) output, a commercially available RF demodulator (RFD-1) is required. The RF demodulator changes the RF signal to a digital signal which is then processed by the receiver at the digital input jacks. For more details, refer to the instruction manual supplied with the RFD-1.

Selecting a Sound Mode

To ensure the best possible surround sound, be sure to complete the set up procedures described in "Setting Up for Surround Sound" (starting on page 14) before using the sound modes. This is particularly important when using the **DD** (Dolby) sound mode.

DSP mode

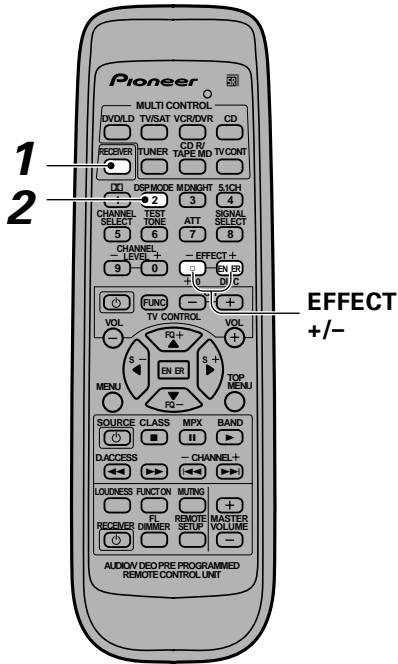

1 Press RECEIVER.

This sets the remote to select the sound mode.
(You can skip this step when using the controls on the receiver.)

2 Press DSP MODE to select the sound mode.

Each press changes the DSP mode as follows:

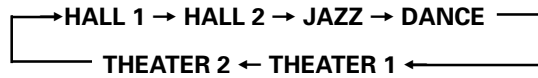

The amount of effect of each DSP mode can be adjusted in the range of 10 to 90 (the default setting is 70) by pressing EFFECT +/-.

DSP MODE

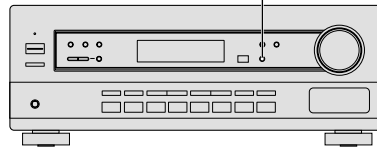

DVD 5.1 ch. input playback

Connect a DVD player with 5.1 channel output to enjoy the surround sound created by 5.1 channel playback.

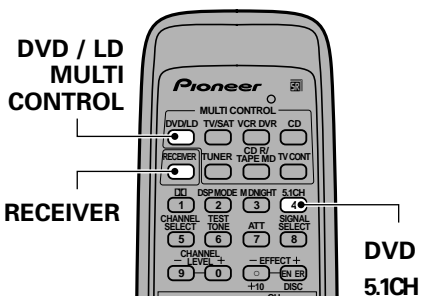

There are two ways to switch on DVD 5.1 CH mode. With the remote control press the DVD/LD MULTI CONTROL button. Then press the RECEIVER button and number button 4 (DVD 5.1CH). On the main unit simply press the DVD 5.1CH button.

Press number button 4 (DVD 5.1CH) on the remote to go back to the DVD/LD mode control. To exit this mode using the main unit simply press other function button (DVD/LD, etc.).

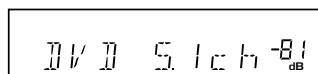
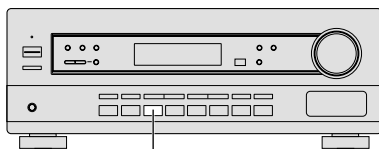

- When 5.1 ch input is selected, Dolby mode, DSP mode, SIGNAL SELECT, ATT, DIRECT, TONE, MIDNIGHT mode, LOUDNESS cannot be operated.
- When 5.1ch input is selected, only the volume level and channel levels can be set.

ADVANCED THEATER mode (Dolby Digital/DTS mode)

Switch on the Dolby/DTS mode by pressing the **DD** button. When Dolby/DTS/ mode is ON, Dolby Pro Logic, Dolby Digital and DTS, and signal processing is performed automatically corresponding to the input signal. Use this button to cycle through the various modes.

For all modes other than STANDARD, DSP is switched on and will appear in the display.

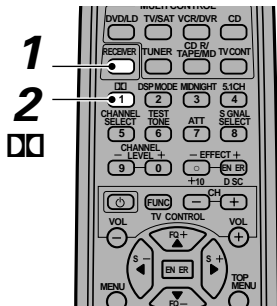

1 Press RECEIVER.

This sets the remote to select the sound mode.
(You can skip this step when using the controls on the receiver.)

2 Switch the Dolby/DTS mode on and off by pressing **DD** on the remote control or **DD**/DTS on the front panel.

Each press changes the display as follows.

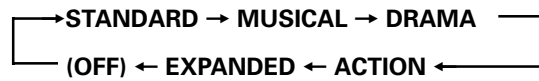

DD /DTS

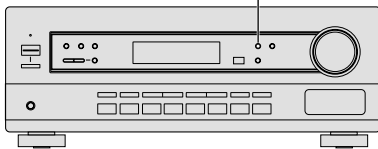

Refer to page 27 for more details about each surround effect.



- The effects of Dolby/DTS mode can be adjusted in the range of 10 to 90 by pressing EFFECT +/- (the default setting is 70). Also, the effect level can be set in each Dolby/DTS mode by pressing the EFFECT +/- button. The STANDARD mode cannot be changed.

Using MIDNIGHT Listening Mode

When the volume is low, surround effects tend to become less than satisfactory. Turn the MIDNIGHT listening mode on to enjoy the effects of quality surround sound even at low volumes. This mode allows you to hear effective surround sound of movies at low volume levels.

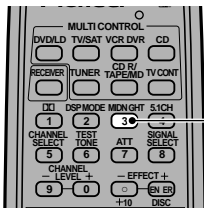

MIDNIGHT

Press MIDNIGHT.

Each press switches MIDNIGHT listening mode on or off.

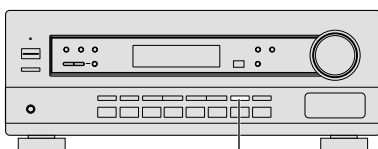

MIDNIGHT



The effect automatically adjusts according to the volume level.

Using the Tuner

Finding a Station

The following steps show you how to tune in to FM and AM radio broadcasts using the automatic (search) and manual (step) tuning functions. If you already know the exact frequency of the station you want to listen to, see Tuning Directly to a Station on the following page. Once you are tuned to a station you can memorize the frequency for recall later—see Memorizing Stations on the next page for more on this.

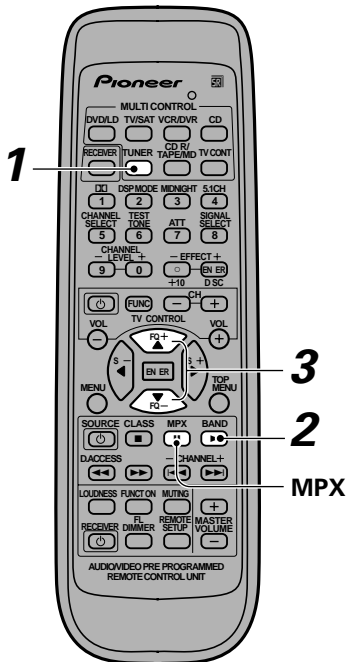

1 Press the **TUNER** button on the remote control.

Make sure the DIRECT FUNCTION is ON (see p. 22).

2 Use the **BAND** button to change the band (FM or AM), if necessary.

Each press switches the band between FM and AM (on the front panel use the FM/AM button).

3 Tune to a station.

Automatic tuning

To search for stations in the currently selected band, press and hold either the **FQ. +** or **FQ. -** button for about a second. The receiver will start searching for the next station, stopping when it has found one. Repeat this step to search for other stations.

Manual tuning

To change the frequency one step at a time, press the **FQ. + / FQ. -** (**▲▼**) buttons.

To change frequency more quickly, press and hold the **FQ. + / FQ. -** buttons until the desired frequency is reached, then release.

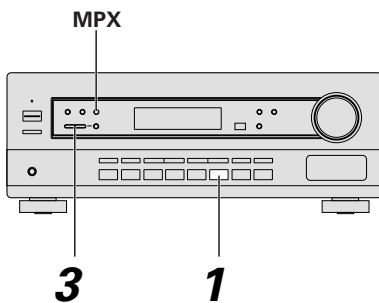

MPX mode

If the signal is weak or there is a lot of noise in the radio reception, press the MPX button to switch the receiver into MONO reception mode. This should improve the sound quality and allow you to enjoy the broadcast.

Tuning Directly to a Station

Sometimes, you'll already know the frequency of the station you want to listen. In this case, you can simply enter the frequency directly using the number buttons on the remote control (this function is not available using the front panel controls of the receiver).

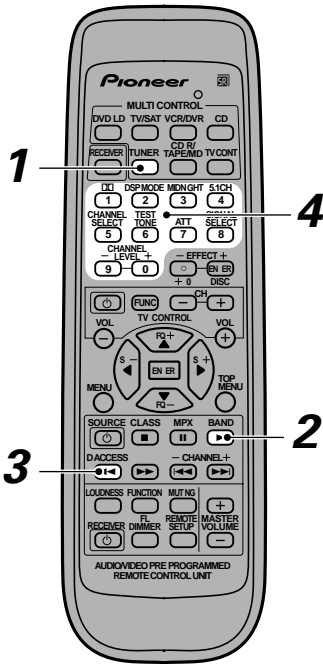

1 Press the **TUNER** button on the remote control.

Make sure the DIRECT FUNCTION is ON (see p. 22).

2 Press the **BAND** button to select either FM or AM.

Each press switches the band between FM and AM. On the receiver, pressing the FM/AM button switches between bands.

3 Press **D. ACCESS (DIRECT ACCESS)**.

4 Use the number buttons to enter the frequency of the radio station.

Example:

To tune to 106.00 (FM), press **1-0-6-0-0**

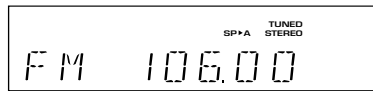

If you make a mistake while inputting the frequency, press the **D.ACCESS** button twice to cancel the frequency and start again.

Memorizing Stations

If you often listen to a particular radio station, it's convenient to have the receiver store the frequency for easy recall whenever you want to listen to that station. This saves the effort of manually tuning in each time. The VSX-D309 can memorize up to 33 stations, stored in three banks, or classes, (A, B and C) of 10 stations each. When memorizing FM frequencies, the receiver also stores the MPX setting (auto stereo or mono, see p.32). The process for memorizing stations is only possible from the controls on the front panel of the receiver.

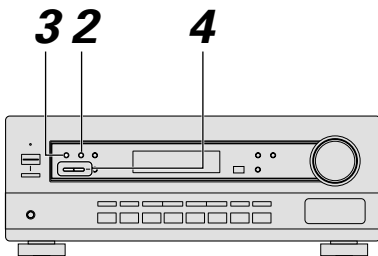

1 Tune to a station you want to memorize.

See Finding a Station and Tuning Directly to a Station, on pages 32 and this page, for more on how to do this.

2 Press **MEMORY**.

The display shows a blinking memory class.

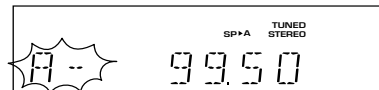

3 Press CLASS to select one of the three classes.

Repeatedly pressing this button cycles through the three available classes, A, B and C.

4 Press STATION +/- to select the desired station memory number.

Pressing these buttons repeatedly cycles through the 10 available station memories in each class. After choosing the location you want, the preset class and number blink for about 5 seconds and the receiver stores the station. **Repeat steps 1 to 4 to memorize up to 30 stations.**

Recalling Memorized Stations

Having memorized up to 33 stations (see the previous page for how to do this), you can be listening to a station with a couple of button presses.

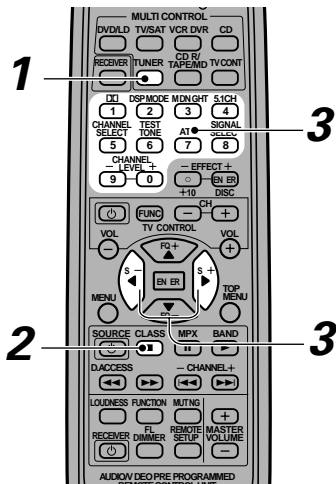

1 Press the TUNER button on the remote control.

Make sure the DIRECT FUNCTION is ON (see p. 22).

2 Press CLASS to select the class in which the station is stored.

Repeatedly pressing this button cycles through the three available classes, A, B and C.

3 Use the STATION +/- buttons to select the station memory in which the station is stored.

Alternatively, recall the station memory using the number buttons on the remote control.



If the receiver is left disconnected from the AC power outlet for a lengthy period (more than one month), the station memories will be lost and will have to be reprogrammed.

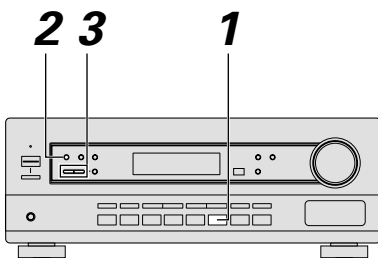

Making an Audio or a Video Recording

The following steps show you how to make an audio or a video recording from the built in tuner, or from an audio or video source connected to the receiver (such as a CD player or TV). Recordings can be made to a CD-Recorder, cassette deck, MD, VCR, or DVR deck connected to the CD-R/TAPE/MD, VCR or DVR in/out connectors.



The receiver's volume, balance tone (bass, treble, loudness), and surround effects (Dolby Pro Logic/Dolby Digital and DSP settings) have no effect on the recorded signal.

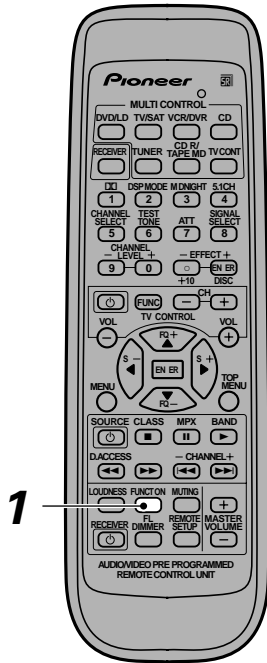

1 Press the MULTI CONTROL button on the remote control of the source component .

Make sure the DIRECT FUNCTION is ON (see p, 22). All functions except MONITOR are accessible from the remote control. On the receiver, select the source directly using the front panel buttons.

2 Prepare the program source.

Tune to the radio station, load the CD, etc. For a video recording load the video, DVD etc.

3 Insert a blank tape, MD, video etc. into the recording device connected to either CD-R/TAPE/MD or VCR/DVR and set the recording levels.

Refer to the instructions that came with the recorder if you are unsure how to do this. Most video recorders set the audio recording level automatically—check your video's instruction manual if you are unsure whether yours has manual controls.

4 Start recording, then start playback of the source component.

Record MONITOR

You can listen to (monitor) the recording as it's being made using the MONITOR button on the front panel if your recording components are connected to the CD-R/TAPE/MD input (a cassette deck would have to have a record monitor function).

Press the MONITOR button to switch between the recorded signal and the original source signal.

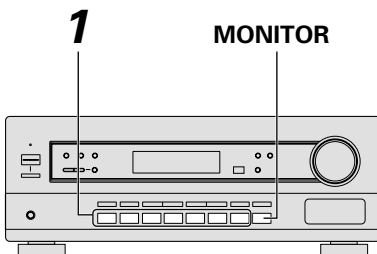

Controlling the Rest of Your System

CD/MD/CD-R/VCR/LD Player Controls



This remote control can control these components after entering the proper codes (see p.20-21).

Use MULTI CONTROL buttons to put the remote control in the stated mode.

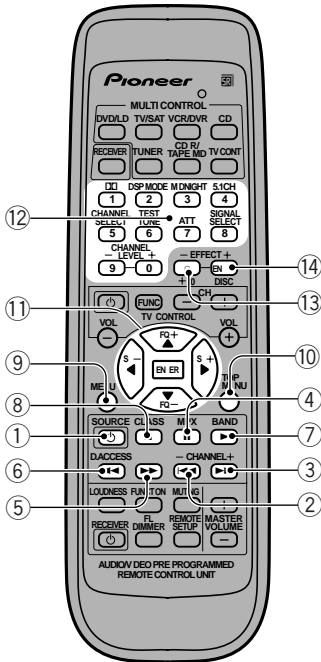

① **POWER SOURCE**

Press to switch the CD, MD, CD-R, VCR OR LD player between **STANDBY** and **ON**.

② **REVERSE**

Press to return to the start of the current track. Repeated presses skips to the start of previous tracks. When controlling a VCR, use this button to go back channels (channel -).

③ **SKIP FORWARD**

Press to advance to the start of the next track. Repeated presses skips to the start of following tracks. When controlling a VCR, use this button to go forward channels (channel +).

④ **PAUSE**

Press to pause playback.

⑤ **FAST FORWARD**

Hold down for fast forward playback.

⑥ **FAST REVERSE**

Hold down for fast reverse playback.

⑦ **PLAY**

Press to start playback.

⑧ **STOP**

Press to stop playback (on some models, pressing this when the disc is already stopped will cause the disc tray to open).

⑨ **MENU**

Press to advance to the start of the next track. Repeated presses skips to the start of following tracks.

⑩ **TOP MENU**

Press to return to the start of the current track. Repeated presses skips to the start of previous tracks.

⑪ **LEFT, RIGHT, UP, DOWN & ENTER buttons**

These buttons can be used play or stop (etc.) many components and also to navigate DVD menus/options. Specifically:

- ◀ to rewind or reverse program source
- ▶ to fast forward program source
- ▲ to pause program source
- ▼ to stop program source

ENTER to play program source

▲▼ pressed together to start recording (for recording devices only).

⑫ **Number Buttons**

Used to directly access tracks on a program source.

⑬ **● Button**

Use this button to select tracks higher than 10 (like a +10 button). Press this button and the remaining number to get the track (● + 3 = track 13).

⑭ **ENTER (DISC) Button**

For a multiple CD/ CD-R player use this button to choose the disc. On an MD player use it ejects the disc, on a VCR it switches between the VDR tuner and the TV tuner. On an LD it changes sides of the LD.

Cassette Deck Controls



This remote control can control these components after entering the proper codes (see p.20-21).

Use MULTI CONTROL buttons to put the remote control in the stated mode.

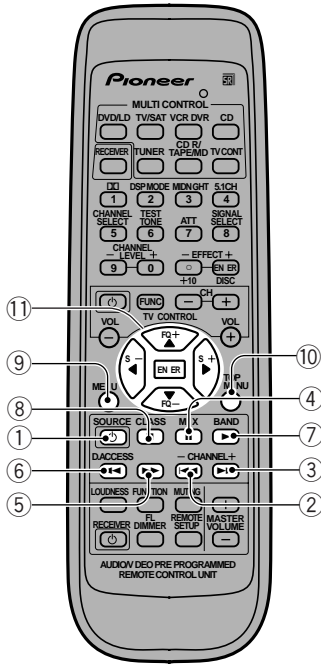

① **POWER SOURCE**

Press to switch the cassette deck between **STANDBY** and **ON** (not possible on all models).

② **REVERSE**

Use to play the reverse side of the tape on a reversible deck.

③ **FORWARD**

Use to play the forward side of the tape on a reversible deck.

④ **PAUSE**

Press to pause playback or recording.

⑤ **FAST FORWARD**

Press to fast forward the tape. Pressing during playback starts forward search.

⑥ **REVERSE SEARCH**

Press to rewind the tape. Pressing during playback starts reverse search.

⑦ **PLAY**

Press to start playback.

⑧ **STOP**

Press to stop playback.

⑨ **MENU**

Use this button to do a rewind music search.

⑩ **TOP MENU**

Use this button to do a forward music search.

⑪ **THESE CONTROLS CAN BE USED FOR DECK ONE OF A DUAL TAPE DECK**

▲ : Press to pause the tape.

▼ : Press to stop the tape.

ENTER : Press to start playback

◀ : Press to rewind the tape.

▶ : Press fast forward the tape

FOR DECK TWO OR ANY DECK THAT CAN RECORD:

▲▼ : pressed together to start recording

DVD/DVR Player Controls



This remote control can control these components after entering the proper codes (see p.20-21).

Use MULTI CONTROL buttons to put the remote control in the stated mode.

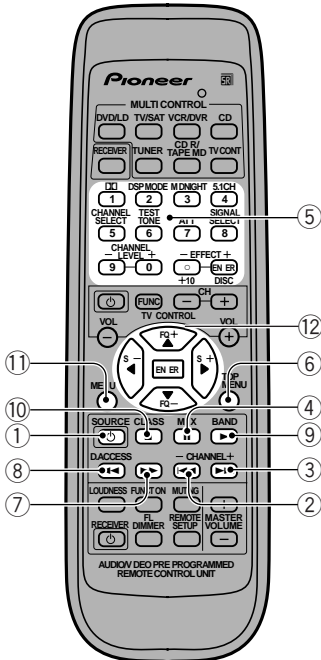

① **POWER SOURCE**

Press to switch the DVD/DVR player between STANDBY and ON.

② **REVERSE**

Press to return to the start of the current chapter (track). Repeated presses skips to the start of previous tracks. When controlling a DVR, use this button to go back channels (channel -).

③ **FAST FORWARD**

Press to advance to the start of the next chapter (track). Repeated presses skips to the start of following tracks. When controlling a DVR, use this button to go forward channels (channel +).

④ **PAUSE**

Press to pause playback (on some models this will freeze-frame the picture).

⑤ **Number buttons**

Use the number buttons to navigate the on-screen display.

The **ENTER** button is used as a **SETUP** button for the DVD players internal menus. The **●** button is used to select tracks higher than 10 (+10 button).

⑥ **TOP MENU**

Use to display the lead trailer on a DVD.

⑦ **FAST FORWARD**

Hold down for fast forward playback.

⑧ **FAST REVERSE**

Hold down for fast reverse playback.

⑨ **PLAY**

Press to start playback (on some models, pressing this when the disc tray is empty will cause the disc tray to open).

⑩ **STOP**

Press to stop playback (on some models, pressing this when the disc is already stopped will cause the disc tray to open).

⑪ **MENU**

Displays menus concerning the current DVD or DVR you are using.

⑫ **USE THESE BUTTONS TO NAVIGATE DVD MENUS**

▲ : up

▼ : down

ENTER: enter the command selected

◀ : left

▶ : right

▲▼ : pressed together starts recording

DTV Controls



This remote control can control these components after entering the proper codes (see p.20-21).

Use MULTI CONTROL buttons to put the remote control in the stated mode.

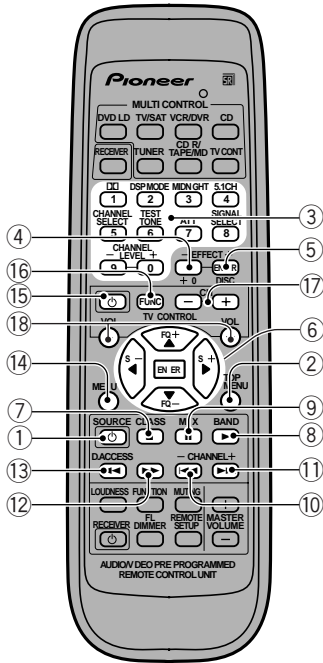

- ① **SOURCE**
Press to switch the DTV on or off.
- ② **TOP MENU**
Press to clear the DTV menu.
- ③ **Number buttons**
Use to select a specific TV channel.
- ④ **(+10) button**
Use to add a decimal point when selecting a specific TV channel.
- ⑤ **ENTER (DISC) button**
Use to enter a channel.
- ⑥ **▲/▼/◀/▶/ENTER**
Press to select or adjust and navigate items on the menu screen.
ENTER : Use to bring up the DTV menus.

- ⑦ **■**
Use to switch DTV audio tracks
- ⑧ **▶**
Use to get INFO on the DTV program.
- ⑨ **||**
Use as the GUIDE button for navigating programming.
- ⑩ **◀◀**
Use to choose the RED commands on a DTV menu.
- ⑪ **▶▶**
Use to choose the YELLOW commands on a DTV menu.
- ⑫ **▶▶**
Use to choose the GREEN commands on a DTV menu.
- ⑬ **◀◀**
Use to choose the BLUE commands on a DTV menu.
- ⑭ **MENU**
Use to select different menus from the DTV functions.

THESE FOUR BUTTONS ARE DEDICATED TV CONTROL BUTTONS FOR ANY TYPE OF TV SETUP.

- ⑮ **STANDBY/ON (power)**
Press to switch the TV or CATV between **STANDBY** and **ON**.
- ⑯ **TV FUNC. (TV only)**
Press to switch the TV input (not possible with some models).
- ⑰ **CHANNEL +/-**
Use to select channels.
- ⑱ **TV VOL +/-**
Use to adjust the TV volume.

Cable TV/Satellite TV/TV Controls



This remote control can control these components after entering the proper codes (see p.20-21).

Use MULTI CONTROL buttons to put the remote control in the stated mode.

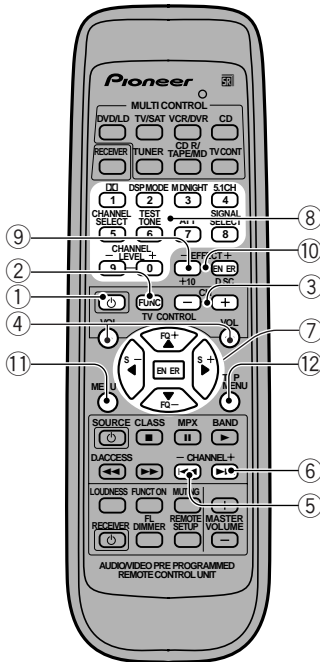

THE FIRST FOUR BUTTONS ARE DEDICATED TV CONTROL BUTTONS FOR ANY TYPE OF TV SETUP.

- ① **STANDBY/ON (power)**
Press to switch the TV or CATV between **STANDBY** and **ON**.
- ② **TV FUNC. (TV only)**
Press to switch the TV input (not possible with some models).
- ③ **CHANNEL +/-**
Use to select channels.
- ④ **TV VOL +/- (TV only)**
Use to adjust the TV volume.
- ⑤ **◀◀**
Use to move to lower numbered channels
- ⑥ **▶▶**
Use to move to higher numbered channels
- ⑦ **▲/▼/◀/▶/ENTER**
Press to select or navigate and adjust items on the menu screen.
- ⑧ **NUMBER buttons**
Use to select channels directly.
- ⑨ **+10 button**
Use to select channels higher than 10.
- ⑩ **EFFECT +/-**
For TV and cable TV use this button to immediately enter a new channel (CHANNEL ENTER function). For satellite TV use this button to exit the menu screen.
- ⑪ **MENU**
Use to select the menu screen.
- ⑫ **TOP MENU**
Use to bring up the GUIDE on a satellite TV.

Troubleshooting

Incorrect operations are often mistaken for trouble and malfunctions. If you think that there is something wrong with this component, check the points below. Sometimes the trouble may lie in another component. Investigate the other components and electrical appliances being used. If the trouble cannot be rectified even after exercising the checks listed below, ask your nearest PIONEER authorized service center or your dealer to carry out repair work.

Symptom	Cause	Remedy
The power does not turn ON.	<ul style="list-style-type: none"> The power plug is disconnected. The protection circuit may have been activated. 	<ul style="list-style-type: none"> Connect the power plug to the wall outlet. Disconnect the power plug from the outlet, and insert again.
The unit does not respond when the buttons are pressed.	<ul style="list-style-type: none"> Static electricity caused by dry air. 	<ul style="list-style-type: none"> Disconnect the power plug from the outlet, and insert again.
No sound is output when a function is selected.	<ul style="list-style-type: none"> Improper connections. Sound is muted. The volume is turned down. The MONITOR is ON. Speakers are turned OFF. 	<ul style="list-style-type: none"> Make sure the component is connected correctly (refer to pages 8 to 12). Press MUTING on the remote control. Adjust MASTER VOLUME. Press the MONITOR button. Press SPEAKERS to select the speakers you connected.
No image is output when a function is selected.	<ul style="list-style-type: none"> Improper connections. The input source is not properly selected. 	<ul style="list-style-type: none"> Make sure the component is connected correctly (refer to pages 9-11). Press the correct function button.
Considerable noise in radio broadcasts.	<ul style="list-style-type: none"> Incorrect frequency. The antenna is not connected. RF (AC-3) and/or digital cables are near the antenna terminals and wires. 	<ul style="list-style-type: none"> Tune in the correct frequency. Connect the antenna (refer to page 8). Route RF (AC-3) and digital cables away from the antenna terminals and wires.
FM broadcasts		
	<ul style="list-style-type: none"> The FM antenna is not fully extended or is poorly positioned. Weak radio signals. 	<ul style="list-style-type: none"> Fully extend the FM wire antenna, position for best reception, and secure to a wall. Connect an outdoor FM antenna (refer to page 8).
AM broadcasts		
	<ul style="list-style-type: none"> The AM antenna is poorly positioned. Weak radio signals. Interference cause by other equipment (fluorescent lamp, motor, etc.). 	<ul style="list-style-type: none"> Adjust the direction and position for best reception. Connect an additional internal or external AM antenna (refer to page 8). Turn off the equipment causing the noise or move it away from the receiver. Place the antenna farther away from the equipment causing the noise.

Symptom	Cause	Remedy
Broadcast stations cannot be selected automatically.	<ul style="list-style-type: none"> Weak radio signal. 	<ul style="list-style-type: none"> Connect an outdoor antenna (refer to page 8).
No sound from surround or center speakers.	<ul style="list-style-type: none"> Speaker settings are incorrect. The rear and/or center levels are turned down. The surround and/or center speakers are disconnected. 	<ul style="list-style-type: none"> Refer to "SPEAKER setting mode" on page 15 to check the speaker settings. Refer to "Setting the volume level of each channel" on page 19 to check the speaker levels. Connect the speakers (refer to page 12).
Sound is produced from other components, but not from LD or DVD player.	<ul style="list-style-type: none"> SIGNAL SELECT is set incorrectly. The digital inputs are assigned incorrectly, or not at all. 	<ul style="list-style-type: none"> Set SIGNAL SELECT to "DIGITAL" or "ANALOG" according to the type of connections made. (refer to page 28). Set the digital input settings correctly (refer to page 18-19).
No sound is output or a noise is output when software with DTS is played back.	<ul style="list-style-type: none"> SIGNAL SELECT is set to "ANALOG". A DVD player not compatible with DTS is used, or the setting of DVD player is incorrect. The digital output level is adjusted on a CD player or other component equipped with digital output level adjustment capability. (The DTS signal has been altered by the player, and cannot be read.) 	<ul style="list-style-type: none"> Make digital connections (refer to page 11) and set SIGNAL SELECT to "DIGITAL" (refer to page 28). Refer to the instruction manual supplied with the DVD player. Set the digital volume level of the player to full, or to the neutral position.
When a search is performed by a DTS compatible CD player during playback, noise is output.	<ul style="list-style-type: none"> The search function performed by the player slightly alters the digital information, making it unreadable. 	<ul style="list-style-type: none"> This is not a malfunction, but be sure to turn the volume down to prevent the output of loud noise from your speakers.
Cannot be remote controlled.	<ul style="list-style-type: none"> The remote control batteries have worn out. Too far away or bad angle of operation. There is an obstacle between the receiver and the remote control. Strong light such as fluorescent light is shining onto the unit's remote control signal light-receiving window. 	<ul style="list-style-type: none"> Replace the batteries (refer to page 7). Operate within 23 feet (7 m), 30° of the remote sensor on the front panel (refer to page 7). Remove the obstacle or operate from another position. Avoid exposing the remote sensor on the front panel to direct light.
The display is dark or off.	<ul style="list-style-type: none"> The FL DIMMER button is pushed. 	<ul style="list-style-type: none"> Press FL DIMMER on the remote control repeatedly to return to the default.

If the unit does not operate normally due to external effects such as static electricity

Disconnect the power plug from the outlet and insert again to return to normal operating conditions.

Preset Code List

Device	Manufacturer	Manufacturer Code	Device	Manufacturer	Manufacturer Code
DVD	TOSHIBA	001	CD	DENON	309
	SONY	002		RCA	302, 319, 300, 313
	PANASONIC	003		PHILIPS	312, 322
	JVC	004		YAMAHA	314, 315, 328
	SAMSUNG	005		JVC	303
	SHARP	006		TEAC	305, 306, 324, 325, 327
	AKAI	007		ONKYO	307, 308, 320
	RCA	009		MARANTZ	323, 312, 324
PIONEER	000, 003, 111	SANYO		313	
LD	SONY	101		OPTIMUS	300
	PANASONIC	105, 106	PIONEER	300	
	KENWOOD	103	CD-R	PHILIPS	346
	PHILIPS	104		PIONEER	345
	RCA	107	TAPE	SONY	801, 806
	mitsubishi	100		TECHNICS	803
PIONEER	100, 111	KENWOOD		804, 807	
TV	RCA	601, 615, 616, 617		TEAC	805
		610, 623, 621, 602, 618		DENON	810
	ZENITH	603, 620		ONKYO	808, 809
	MAGNAVOX	612, 629, 607, 610, 603		YAMAHA	811, 812
	GE	611, 628, 601, 608, 607, 610, 617, 602, 618	JVC	802	
		608, 622, 607	FISHER	813	
	PANASONIC	604	RCA	800	
	SONY	605, 626, 602, 621	OPTIMUS	800	
	TOSHIBA	609, 610, 602, 621	PIONEER	800	
	MITSUBISHI	606, 624, 625, 610, 618	MD	SONY	901
	HITACHI	613, 623		KENWOOD	903
	JVC	602, 619, 627		SHARP	902
	SHARP	614, 621		TEAC	904
	SANYO	607		ONKYO	905
	PHILIPS	610, 623, 621, 602		DENON	906
	GOLDSTAR	630	PIONEER	900, 907(FOR DAT), 902	
	GRADIENT	610, 623, 621, 602	VCR	RCA	401, 413, 415, 406, 408, 414, 405, 411, 432, 433, 402, 418, 419
	RADIO SHACK	600			ZENITH
	PIONEER	600		MAGNAVOX	414, 408, 426, 403
CATV	JERROLD	701, 702, 703, 704, 711, 712, 713, 714, 715, 716		FISHER	412, 426, 427, 410, 425, 420
		705, 706, 708, 709		PANASONIC	408, 432, 433
	S.A.	707, 710, 717		TOSHIBA	405, 409, 426
	ZENITH	700		JVC	407, 428, 429, 430, 431, 408, 414
	PIONEER	700		HITACHI	406, 434, 436, 408, 401
SAT	RCA	201, 203		SONY	404, 416, 417, 457, 458, 459, 408
	SONY	202		MITSUBISHI	409, 420, 421, 422, 423, 424, 408, 407
	ECHOSTAR	205	SANYO		410, 425, 435, 412
	PIONEER	200	SHARP	402, 418, 419	
DTV	PANASONIC	227	GOLDSTAR	411, 409	
	PIONEER	207, 226	GRANDIENTE	441	
DVR	PIONEER	456	OPTIMUS	408, 432, 433, 402, 418, 419	
CD	SONY	301, 316, 317, 318	PIONEER	400	
	TECHNICS	304, 326			
	KENWOOD	310, 311, 321			

Specifications

Amplifier Section

Continuous average power output of 60 watts* per channel, min., at 8 ohms, from 40 Hz to 20,000 Hz with no more than 0.2% total harmonic distortion (front).**

* Measured pursuant to the Federal Trade Commission's Trade Regulation rule on Power Output Claims for Amplifiers.

** Measured by Audio Spectrum Analyzer.

Continuous Power Output

Front 60 W per channel (1kHz, 0.8 %, 8 Ω)
 Center 60 W (1kHz, 0.8 %, 8 Ω)
 Surround 60 W per channel (1kHz, 0.8 %, 8 Ω)

Input (Sensitivity/Impedance)

CD, VCR/DVR, CD-R/TAPE/MD, DVD/LD, TV/SAT
 200 mV/47 kΩ

Frequency Response

CD, VCR/DVR, CD-R/TAPE/MD, DVD/LD, TV/SAT
 5 Hz to 100,000 Hz ± 0.3 dB

Output (Level/Impedance)

VCR/DVR REC, CD-R/TAPE/MD REC
 200 mV/2.2 kΩ

Tone Control

BASS ± 6 dB (100 Hz)
 TREBLE ± 6 dB (10 kHz)
 LOUDNESS +9 dB/+9 dB (100 Hz/10 kHz)

Signal-to-Noise Ratio (IHF, short circuited, A network)

CD, VCR/DV-R, CD-R/TAPE/MD, DVD/LD, TV/SAT
 96 dB

Signal-to Noise Ratio [EIA, at 1 W (1 kHz)]

CD, VCR/DV-R, CD-R/TAPE/MD, DVD/LD, TV/SAT
 79 dB

Video Section

Input (Sensitivity/Impedance)

VCR/DVR, DVD/LD, TV/SAT 1 Vp-p/75 Ω

Output (Level/Impedance)

VCR/DVR, MONITOR 1 Vp-p/75 Ω

Frequency Response

VCR/DVR, MONITOR
 5 Hz to 7 MHz ± 0.3 dB

Signal-to-Noise Ratio 55 dB

Cross Talk 55 dB

FM Tuner Section

Frequency Range 87.5 MHz to 108 MHz
 Usable Sensitivity

..... Mono:13.2 dBf, IHF (1.3 μ V/ 75 Ω)

50 dB Quieting Sensitivity Mono: 20.2 dB

Stereo: 38.6 dBf

Signal-to-Noise Ratio Mono: 73 dB (at 85 dBf)

Stereo: 70 dB (at 85 dBf)

Distortion Stereo: 0.5 % (1 kHz)

Alternate Channel Selectivity 60 dB (400 kHz)

Stereo Separation 40 dB (1 kHz)

Frequency Response 30 Hz to 15 kHz (± 1) dB

Antenna Input (DIN) 75 Ω unbalanced

AM Tuner Section

Frequency Range 530 kHz to 1,700 kHz

Sensitivity (IHF, Loop antenna) 350 μ V/m

Selectivity 25 dB

Signal-to-Noise Ratio 50 dB

Antenna Loop antenna

Miscellaneous

Power Requirements AC 120 V, 60 Hz

Power Consumption 180 W

In Standby 1 W

Dimensions 420 (W) x 158 (H) x 391 (D) mm

(16-9/16 (W) x 6-4/16 (H) x 15-6/16 (D) in.)

Weight (without package) 8.4 kg

(18 lb 8 oz.)

Furnished Parts

FM Antenna 1

AM Loop Antenna 1

Dry Cell Batteries

size AA (IEC R6P) 2

Remote Control Unit 1

Operating Instructions 1

NOTE:

Specifications and the design are subject to possible modifications without notice, due to improvements.



Dear Customer:

Selecting fine audio equipment such as the unit you've just purchased is only the start of your musical enjoyment. Now it's time to consider how you can maximize the fun and excitement your equipment offers. This manufacturer and the Electronic Industries Association's Consumer Electronics Group want you to get the most out of your equipment by playing it at a safe level. One that lets the sound come through loud and clear without annoying blaring or distortion-and, most importantly, without affecting your sensitive hearing.

Sound can be deceiving. Over time your hearing "comfort level" adapts to higher volumes of sound. So what sounds "normal" can actually be loud and harmful to your hearing. Guard against this by setting your equipment at a safe level BEFORE your hearing adapts.

To establish a safe level:

- Start your volume control at a low setting.
- Slowly increase the sound until you can hear it comfortably and clearly, and without distortion.

Once you have established a comfortable sound level:

- Set the dial and leave it there.

Taking a minute to do this now will help to prevent hearing damage or loss in the future. After all, we want you listening for a lifetime.

We Want You Listening For A Lifetime

Used wisely, your new sound equipment will provide a lifetime of fun and enjoyment. Since hearing damage from loud noise is often undetectable until it is too late, this manufacturer and the Electronic Industries Association's Consumer Electronics Group recommend you avoid prolonged exposure to excessive noise. This list of sound levels is included for your protection.

Decibel

<u>Level</u>	<u>Example</u>
30	Quiet library, soft whispers
40	Living room, refrigerator, bedroom away from traffic
50	Light traffic, normal conversation, quiet office
60	Air conditioner at 20 feet, sewing machine
70	Vacuum cleaner, hair dryer, noisy restaurant
80	Average city traffic, garbage disposals, alarm clock at two feet.

THE FOLLOWING NOISES CAN BE DANGEROUS UNDER CONSTANT EXPOSURE

90	Subway, motorcycle, truck traffic, lawn mower
100	Garbage truck, chain saw, pneumatic drill
120	Rock band concert in front of speakers, thunderclap
140	Gunshot blast, jet plane
180	Rocket launching pad

Information courtesy of the Deafness Research Foundation.



Should this product require service in the U.S.A. and you wish to locate the nearest Pioneer Authorized Independent Service Company, or if you wish to purchase replacement parts, operating instructions, service manuals, or accessories, please call the number shown below.

8 0 0 – 4 2 1 – 1 4 0 4

Please do not ship your product to Pioneer without first calling the Customer Service Department at the above listed number for assistance.

**PIONEER ELECTRONICS SERVICE, INC.
CUSTOMER SERVICE DEPARTMENT
P.O. BOX 1760, LONG BEACH,
CA 90801-1760, U.S.A.**

For warranty information please see the Limited Warranty sheet included with your product.

Published by Pioneer Corporation.
Copyright © 1999 Pioneer Corporation.
All rights reserved.

PIONEER CORPORATION 4-1, Meguro 1-Chome, Meguro-ku, Tokyo 153-8654, Japan
PIONEER ELECTRONICS [USA] INC. P.O. BOX 1540, Long Beach, California 90801-1540, U.S.A.
PIONEER ELECTRONICS OF CANADA, INC. 300 Allstate Parkway, Markham, Ontario L3R 0P2, Canada
PIONEER ELECTRONIC [EUROPE] N.V. Haven 1087, Keetberglaan 1, 9120 Melsele, Belgium TEL: 03/570.05.11
PIONEER ELECTRONICS AUSTRALIA PTY. LTD. 178-184 Boundary Road, Braeside, Victoria 3195, Australia, TEL: [03] 9586-6300
PIONEER ELECTRONICS DE MEXICO S.A. DE C.V. San Lorenzo Num 1009 3er piso Desp. 302 Col. Del Valle, Mexico D.F. C.P. 03100
TEL: 5-688-52-90